



Guidance System D4/D6

User Manual

Part Number 608461, Revision A



Brooks Automation

Information provided within this document is subject to change without notice, and although believed to be accurate, Brooks Automation assumes no responsibility for any errors, omissions, or inaccuracies.

AcuLigner™, Advan Tag™, AutoTeach™, ATR™, AXM™, BiSymmetrik™, CenterSmart™, Crate to Operate™, CrossingConnect™, DARTS™, Enerta™, e-RMA™, e-Spares™, e-Volution™, Falcon™, FIXLOAD™, FrogLeg™, GuardianPro™, Independent Twin Linear Exchange™, InCooler™, InLigner™, Isoport™, ITLX™, Jet™, Jet Engine™, LEAP™, LeapFrog™, LowProfile™, LPT™, M2 Nano™, Marathon 2, Marathon Express, PASIV™, Pathway™, PowerPak™, PowerTools™, PuroMaxx™, QuadraFly™, Radius™, Radient™, Radient Express™, Reliance™, Reliance ATR™, RetroEase™, SCARA™, SmartPM™, SMIF-INX™, SMIF-LPT™, SPOTLevel™, The New Pathway to Productivity™, Time Optimized Trajectory™, Time Optimal Trajectory™, Time Optimized Path™, TopCooler™, TopLigner™, VacuTran™, VersaPort™, WaferEngine™, LEAP™, Pathway™, GIO, GSB, Guidance 6600, Guidance 6430, Guidance 6420, Guidance 6410, Guidance 6000, Guidance 3400, Guidance 3300, Guidance 3200, Guidance 2600, Guidance 2400, Guidance 2300, Guidance 2200, Guidance 1400, Guidance 1300, Guidance 1200, Guidance 0200 Slave Amplifier, Guidance 0006, Guidance 0004, Guidance Controller, Guidance Development Environment, GDE, Guidance Development Suite, GDS, Guidance Dispense, Guidance Input and Output Module, Guidance Programming Language, GPL, Guidance Slave Board, Guidance System, Guidance System D4/D6, PreciseFlex™ 300, PreciseFlex™ 400, PreciseFlex™ 3400, PreciseFlex™ 1300, PreciseFlex™ 1400, PreciseFlex™ DD4, PreciseFlex™ DD6, PreciseFlex™ DDR, PreciseFlex™ G5400, PreciseFlex™ G5600, PreciseFlex™ G6400, PreciseFlex™ G6410, PreciseFlex™ G6420, PreciseFlex™ G6430, PreciseFlex™ G6600, PreciseFlex™ GSBP Slave Amp, PreciseFlex™ PFD0, PrecisePlace 100, PrecisePlace 0120, PrecisePlace 0130, PrecisePlace 0140, PrecisePlace 1300, PrecisePlace 1400, PrecisePlace 2300, PrecisePlace 2400, PrecisePower 300, PrecisePower 500, PrecisePower 1000, PrecisePower 2000, PreciseVision, and RIO logos are trademarks of Brooks Automation.

Fusion®, Guardian®, MagnaTran®, Marathon®, Razor®, Spartan®, Vision®, Zaris®, and the Brooks and design logo are registered U.S. trademarks of Brooks Automation.

All other trademarks are properties of their respective owners.

© 2024 Brooks Automation. All rights reserved. The information included in this manual is proprietary information of Brooks Automation, and is provided for the use of Brooks customers only and cannot be used for distribution, reproduction, or sale without the express written permission of Brooks Automation.

This technology is subject to United States export Administration Regulations and authorized to the destination only; diversion contrary to U.S. law is prohibited.

<p>Brooks Automation 15 Elizabeth Drive Chelmsford, MA 01824-2400 Tel: +1 978-262-2400 Fax: +1 978-262-2500</p>	<p>Brooks Automation, PreciseFlex Collaborative Robots 201 Lindbergh Avenue Livermore, CA 94551 Tel: +1-408-224-2838</p>
--	---



Worldwide Headquarters

15 Elizabeth Drive
Chelmsford, MA 01824 U.S.A.

Brooks Automation, PreciseFlex Collaborative Robots

201 Lindbergh Avenue
Livermore, CA 94551 U.S.A

Technical Support

Location	Contact	Website
North America	+1-800-447-5007 (Toll-Free) +1-978-262-2900 (Local) +1-408-224-2838 (PreciseFlex™)	http://www.brooks.com/
Europe	support_preciseflex@brooksautomation.com	
Japan	+81 120-255-390 (Toll Free) +81 45-330-9005 (Local)	
China	+86 21-5131-7066	
Taiwan	+886 080-003-5556 (Toll Free) +886 3-5525258 (Local)	
Korea	1800-5116 (Toll Free)	
Singapore	+65 1-800-4-276657 (Toll Free) +65 6309 0701 (Local)	

General Emails

Division	Email Address
Sales	sales_preciseflex@brooksautomation.com
Technical Support	support_preciseflex@brooksautomation.com
Technical Publications	Technical.Publications@brooksautomation.com

Revision History

Revision	ECO	Date	Action	Author
A	EC147360	August 4, 2023	Released manual at Rev. A to follow standard Brooks technical publication styles.	M. Ashenfelder

Table of Contents



1. Safety	1
Safety Setup	1
Authorized Personnel Only	1
Explanation of Hazards and Alerts	2
Safety Text	2
Safety Icons	2
Signal Words and Color	2
Alert Example	3
General Safety Considerations	4
Mechanical Hazards	6
Electrical Hazards	7
Ergonomic Hazards	8
Emergency Stop Circuit (E-Stop)	10
Recycling and Hazardous Materials	10
2. Introduction to the Hardware	11
System Overview	11
System Description	11
System Diagram and Coordinate Systems	13
System Components	16
Major Components	16
Guidance 24x0 Controller	19
Guidance 0200 Slave Amplifier (D6 only)	20
Low-Voltage Power Supply	21
Intelligent Motor Power Supply	22
Valve/Brake Control Board	23
Auxiliary Digital I/O Board	24
Remote Front Panel, E-Stop Box and Manual Control Pendant	25
Remote IO Module	26
Machine Vision Software and Cameras	27
Controller Status Light	27
Machine Safety	29
Voltage and Power Considerations	29
Guidance System Enclosure	30
Releasing a Trapped Operator: Brake Release Switch	31
Mechanical Limit Stops	31
E-Stop Stopping Time and Distance	32
Safety Zones	32
Safety Standards Reference Material	38
Standards Compliance and Agency Certifications	38
Moving Machine Safety	39
3. Installation Information	40
Mounting and Airflow	40
4. Hardware Reference	42

System Interface Panel	42
Auxiliary Digital IO And Camera Power	43
DENSO Motor/Encoder/Brake Connector	47
Digital Input Signals	48
Digital Output Signals/Valve Control	51
Ethernet Interface	55
Optional Analog Input Signals	56
Optional Auxiliary Encoder Interfaces	57
Remote Front Panel/MCP/E-Stop Interface	59
RS-232 Serial Interface	62
Appendices	63
Appendix A: Product Specifications	63
Guidance System D4/D6 Specifications	63
Guidance System D4/D6 Environmental Specifications	66
Appendix B: FAQ	67
Appendix C: Spare Parts Lists	69
Appendix D: System Schematics	70

1. Safety

Safety Setup

Brooks uses caution, warning, and danger labels to convey critical information required for the safe and proper operation of the hardware and software. Read and comply with all labels to prevent personal injury and damage to the equipment.

 DANGER Read the Safety Chapter	
<p>Failure to review the <i>Safety</i> chapter and follow the safety warnings can result in serious injury or death.</p> <ul style="list-style-type: none">• All personnel involved with the operation or maintenance of this product must read and understand the information in this safety chapter.• Follow all applicable safety codes of the facility as well as national and international safety codes.• Know the facility safety procedures, safety equipment, and contact information.• Read and understand each procedure before performing it.	

Authorized Personnel Only

This product is intended for use by trained and experienced personnel. Operators must comply with applicable organizational operating procedures, industry standards, and all local, regional, national, and international laws and regulations.

Explanation of Hazards and Alerts

This manual and this product use industry standard hazard alerts to notify the user of personal or equipment safety hazards. Hazard alerts contain safety text, icons, signal words, and colors.

Safety Text

Hazard alert text follows a standard, fixed-order, three-part format.





- Identify the hazard
- State the consequences if the hazard is not avoided
- State how to avoid the hazard.

Safety Icons

- Hazard alerts contain safety icons that graphically identify the hazard.
- The safety icons in this manual conform to ISO 3864 and ANSI Z535 standards.

Signal Words and Color

Signal words inform of the level of hazard.

	<p>Danger indicates a hazardous situation which, if not avoided, will result in serious injury or death.</p> <p>The Danger signal word is white on a red background with an exclamation point inside a yellow triangle with black border.</p>
	<p>Warning indicates a hazardous situation which, if not avoided, could result in serious injury or death.</p> <p>The Warning signal word is black on an orange background with an exclamation point inside a yellow triangle with black border.</p>
	<p>Caution indicates a hazardous situation or unsafe practice which, if not avoided, may result in minor or moderate personal injury.</p> <p>The Caution signal word is black on a yellow background with an exclamation point inside a yellow triangle with black border.</p>
	<p>Notice indicates a situation or unsafe practice which, if not avoided, may result in equipment damage.</p> <p>The Notice signal word is white on blue background with no icon.</p>



Alert Example

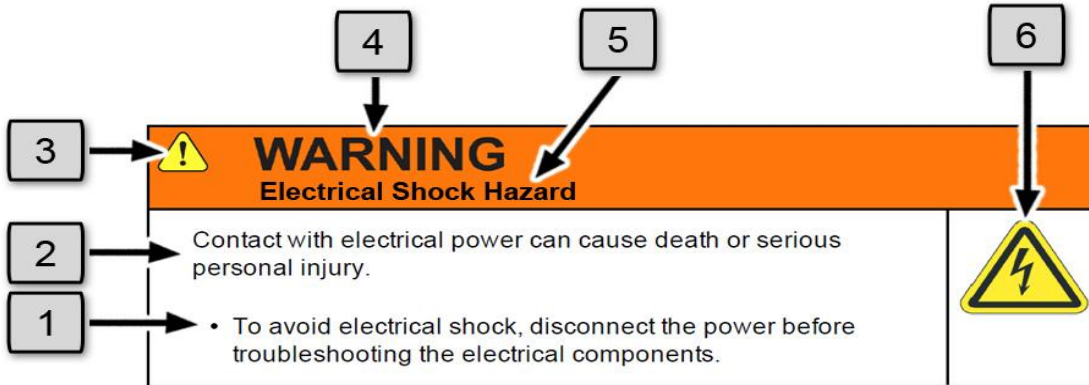

The following is an example of a Warning hazard alert.







Number	Description
1.	How to Avoid the Hazard
2.	Source of Hazard and Severity
3.	General Alert Icon
4.	Signal Word
5.	Type of Hazard
6.	Hazard Symbol(s)



General Safety Considerations



 WARNING Software	
<p>Software is not safety rated. Unplanned motion can occur as long as power is supplied to the motors. Maximum torque could be momentarily applied that may cause equipment damage or personal injury.</p> <ul style="list-style-type: none">• Only operate the robot with its covers installed.• Guarantee that safety controller features are in place (for example, an emergency stop button and protective stop).• Regularly test safety components to prove that they function correctly.	 



 WARNING Robot Mounting	
<p>Before applying power, the robot must be mounted on a rigid test stand, secure surface, or system application. Improperly mounted robots can cause excessive vibration and uncontrolled movement that may cause equipment damage or personal injury.</p> <ul style="list-style-type: none">• Always mount the robot on a secure test stand, surface, or system before applying power.	



 WARNING Do Not Use Unauthorized Parts	
<p>Using parts with different inertial properties with the same robot application can cause the robot's performance to decrease and potentially cause unplanned robot motion that could result in serious personal injury.</p> <ul style="list-style-type: none">• Do not use unauthorized parts.• Confirm that the correct robot application is being used.	

 WARNING Magnetic Field Hazard	
<p>This product contains magnetic motors that can be hazardous to implanted medical devices, such as pacemakers, and cause personal harm, severe injury, or death.</p> <ul style="list-style-type: none">• Maintain a safe working distance of 30 cm from the motor when with an energized robot if you use a cardiac rhythm management device.	



 CAUTION Unauthorized Service	
<p>Personal injury or damage to equipment may result if this product is operated or serviced by untrained or unauthorized personnel.</p> <ul style="list-style-type: none">• Only qualified personnel who have received certified training and have the proper job qualifications are allowed to transport, assemble, operate, or maintain the product.	

 CAUTION Damaged Components	
<p>The use of this product when components or cables appear to be damaged may cause equipment malfunction or personal injury.</p> <ul style="list-style-type: none">• Do not use this product if components or cables appear to be damaged.• Place the product in a location where it will not get damaged.• Route cables and tubing so that they do not become damaged and do not present a personal safety hazard.	



 CAUTION Inappropriate Use	
<p>Use of this product in a manner or for purposes other than for what it is intended may cause equipment damage or personal injury.</p> <ul style="list-style-type: none">• Only use the product for its intended application.• Do not modify this product beyond its original design.• Always operate this product with the covers in place.	

 CAUTION Seismic Restraint	
<p>The use of this product in an earthquake-prone environment may cause equipment damage or personal injury.</p> <ul style="list-style-type: none"> The user is responsible for determining whether the product is used in an earthquake prone environment and installing the appropriate seismic restraints in accordance with local regulations. 	

Mechanical Hazards

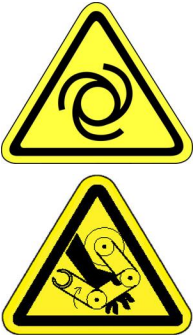

 CAUTION Pinch Point	
<p>Moving parts of the product may cause squeezing or compression of fingers or hands resulting in personal injury.</p> <ul style="list-style-type: none"> Do not operate the product without the protective covers in place. 	



 WARNING Automatic Movement	
<p>Whenever power is applied to the product, there is the potential for automatic or unplanned movement of the product or its components, which could result in personal injury.</p> <ul style="list-style-type: none"> Follow safe practices for working with energized products per the facility requirements. Do not rely on the system software or process technology to prevent unexpected product motion. Do not operate the product without its protective covers in place. While the collaborative robotics system is designed to be safe around personnel, gravity and other factors may present hazards and should be considered. 	



 CAUTION Vibration Hazard	
<p>As with any servo-based device, the robot can enter a vibratory state resulting in mechanical and audible hazards. Vibration indicates a serious problem. Immediately remove power.</p> <ul style="list-style-type: none">• Before energizing, ensure the robot is bolted to a rigid metal chamber or stand.	

Electrical Hazards

Refer to the specifications of the *Guidance Controller Quick Start Guide* for the electrical power.



 DANGER Electrical Shock Hazard	
<p>Contact with electrical power can cause personal harm and serious injury.</p> <ul style="list-style-type: none">• To avoid electrical shock, disconnect the power before troubleshooting the electrical components.• Check the unit's specifications for the actual system power requirements and use appropriate precautions.• Never operate this product without its protection covers on.	



 WARNING Electrical Burn	
<p>Improper electrical connection or connection to an improper electrical supply can result in electrical burns resulting in equipment damage, serious injury, or death.</p> <ul style="list-style-type: none">• Always provide the robot with the proper power supply connectors and ground that are compliant with appropriate electrical codes.	



 WARNING Electrical Fire Hazard	
<p>All energized electrical equipment poses the risk of fire, which may result in severe injury or death. Fires in wiring, fuse boxes, energized electrical equipment, computers, and other electrical sources require a Class C extinguisher.</p> <ul style="list-style-type: none">• Use a fire extinguisher designed for electrical fires (Class C in the US and Class E in Asia).• It is the facility's responsibility to determine if any other fire extinguishers are needed for the system that the robot is in.	

NOTICE
<p>Improper handling of the power source or connecting devices may cause component damage or equipment fire.</p> <ul style="list-style-type: none">• Connect the system to an appropriate electrical supply.• Turn off the power before servicing the unit.• Turn off the power before disconnecting the cables.

Ergonomic Hazards



 CAUTION Heavy Lift Hazard	
<p>Failure to take the proper precautions before moving the robot could result in back injury and muscle strain.</p> <ul style="list-style-type: none">• Use a lifting device and cart rated for the weight of the drive or arm.• Only persons certified in operating the lifting device should be moving the product.	

 CAUTION Tipover Hazard	
<p>This product has a high center of gravity which may cause the product to tip over and cause serious injury.</p> <ul style="list-style-type: none">• Always properly restrain the product when moving it.• Never operate the robot unless it is rigidly mounted.	

 CAUTION Trip Hazard	
<p>Cables for power and communication and facilities create trip hazards which may cause serious injury.</p> <ul style="list-style-type: none">• Always route the cables where they are not in the way of traffic.	

Emergency Stop Circuit (E-Stop)

The integrator of the robot must provide an emergency stop switch.

 WARNING Emergency Stop Circuit	
<p>Using this product without an emergency stop circuit may cause personal injury.</p> <ul style="list-style-type: none">• Customer is responsible for integrating an emergency stop circuit into their system.• Do not override or bypass the emergency stop circuit.	

Recycling and Hazardous Materials

Brooks Automation complies with the EU Directive 2002/96/EU Waste Electrical and Electronic Equipment (WEEE).

The end user must responsibly dispose of the product and its components when disposal is required. The initial cost of the equipment does not include cost for disposal. For further information and assistance in disposal, please email Brooks Automation Technical Support at support@preciseflex@brooksautomation.com.

2. Introduction to the Hardware

System Overview

System Description

The Guidance System D4 is a complete vision guided motion control system that is designed to drive a 4-axis DENSO Robotics SCARA or Cartesian mechanism, such as the HS-45552G. The Guidance System D6 is very similar to the D4, but is slightly larger and contains two additional motor amplifiers to control a 6-axis DENSO Robots Articulated mechanism, such as the VP-6242G. For both versions of the Guidance System, the standard DENSO robot cable plugs directly into the front of the control system with no extra cables or cable converters. Each system is designed to operate a DENSO mechanism at its full capability.

The Guidance System's compact enclosure includes:

- A Guidance 24x0 Controller with integrated motor drives
- A PrecisePower 300/600 Intelligent Motor Power Supply
- A low voltage logic power supply, and an internal fan and filters for cooling

The D6 version also includes a Guidance G0200C Slave Amplifier to control the two additional motors. The controller's software includes a geometric ("kinematic") model of the mechanism that permits the robot to be taught and programmed in Cartesian coordinates. For customers who want to use a DENSO robot but want the features of a Guidance Controller, the Guidance System D4/D6 provides a convenient, ready-to-use alternative to purchasing, mounting, and wiring all of the motion control components necessary for a complete system.

Depending upon the DENSO mechanism that is utilized, the Guidance Controller is equipped with motor drives that provide either a peak current of 20 Amps or 10 Amps per motor. In addition, the controller includes the hardware and firmware necessary to directly interface to the mechanism's unusual serial absolute encoders. Therefore, the Guidance System is able to take full advantage of the mechanism's speed, performance, high resolution, and absolute positioning capability.

To facilitate communicating with other equipment, the Guidance System D4/D6 includes extensive I/O interfaces including Ethernet ports, a RS-232 interface, digital input and output signal channels, and an interface for a remote front panel. Optional integrated hardware is available that provides additional digital input and output channels, analog inputs, and DC power for a camera and its light source. The Guidance System can have several types of peripherals attached to it. These include cameras, remote digital I/O, a hardware manual control pendant, and an E-stop button.

For applications requiring control of additional axes, this system can be networked with other PreciseFlex controllers over Ethernet.

The Guidance System includes a web-based operator interface that is viewed via a standard browser. This interface is used for configuring the system, starting and stopping execution, and monitoring its operation. The web interface can be accessed over a local network or remotely via the Internet. This remote interface is of great benefit in system maintenance and debugging. It is highly recommended that first time users read the *Setup and Operation Quick Start Guide* (PN 0000-DI-00010) for instructions on interfacing a PC to the system controller via the web interface and for general controller operating instructions.

This system is programmed by means of a PC connected through Ethernet. There are three programming modes: a Digital IO (PLC) mode, an embedded language (GPL) mode, and a PC Control mode.



When programmed in the PLC or GPL mode, the PC can be removed after programming is completed and the system will operate standalone. A PC is required for operation in the PC Control mode. For a complete description of the embedded language and its development environment, refer to the *Guidance Programming Language, Introduction to GPL* (PN GPL0-DI-S0010) and the *Guidance Development Environment, Introduction and Reference Manual* (PN GDE0-DI-S0010).

The system is designed to operate with an optional, easy-to-use machine vision software package, "PreciseVision." This vision system can be executed in a PC connected through Ethernet or (in the future) in the motion controller. It provides a complete set of image-processing, measurement, inspection and object finder tools. For more information on vision, refer to the *PreciseVision Machine Vision System, Introduction and Reference Manual* (PN PVS0-DI-S0010).

For a complete description of the system's internal controller hardware, refer to the *Guidance 3000/2000 Controllers, Hardware Introduction and Reference Manual* (PN G3X0-DI-00010).

System Diagram and Coordinate Systems

When the Guidance System D4 is interfaced to a DENSO SCARA mechanism, the major components of the system are as shown in [Figure 2-1](#).

 DANGER Electrical Shock	
<p>Consult the manuals that are provided with the DENSO SCARA mechanism for instructions on the proper installation, mounting and safeguarding of this device.</p> <p>Electrical power should not be applied until the mechanism is in full compliance with these instructions.</p>	

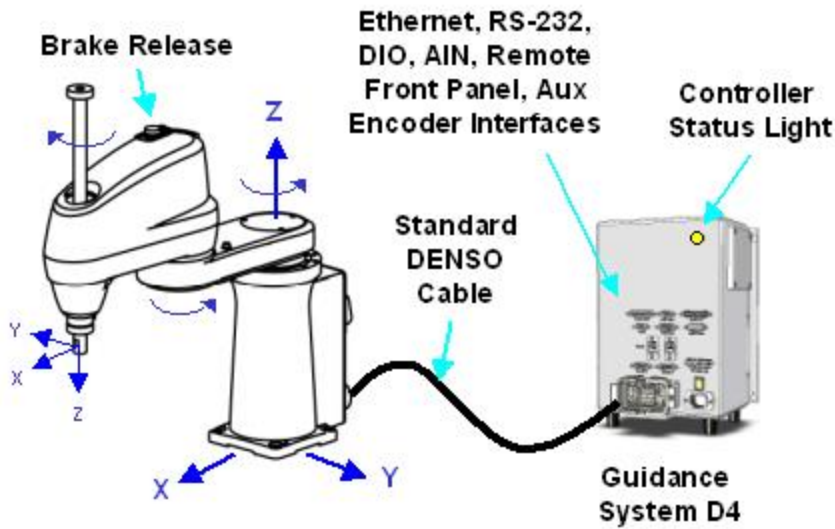



Figure 2-1: Standard DENSO 4-Axis Robot

The World and the Tool coordinate systems for the SCARA robot as well as the positive direction of rotation for each of the robot's rotary axes are shown in [Figure 2-1](#). When the axes are in the positions indicated in this figure, they are all at their 0 positions. That is, when the axes positions are 0, the inner and outer links are aligned and pointing straight out in front of the base, the Z-axis is fully retracted (up), and the Theta is in the middle of its range of travel. When the third axis (the linear Z) moves down, the Z-axis position will increase and the end effector's World Z coordinate will decrease in value.

The linear Z-axis typically includes a fail-safe brake. This brake must be released to move the Z-axis up and down manually. DENSO typically provides a manual brake release button on the top of the mechanism's outer link. Clicking this button when the controller is powered on will release the Z-axis brake while the button is clicked. The user should carefully support the Z-axis when the brake release button is pushed, as the axis will fall due to gravity.

When the Guidance System D6 is interfaced to a DENSO 6-axis Articulated mechanism, the major components of the system are as shown in [Figure 2-2](#).

 DANGER Electrical Shock	
<p>Consult the manuals that are provided with the DENSO 6-axis mechanism for instructions on the proper installation, mounting and safeguarding of this device.</p> <p>Electrical power should not be applied until the mechanism is in full compliance with these instructions.</p>	

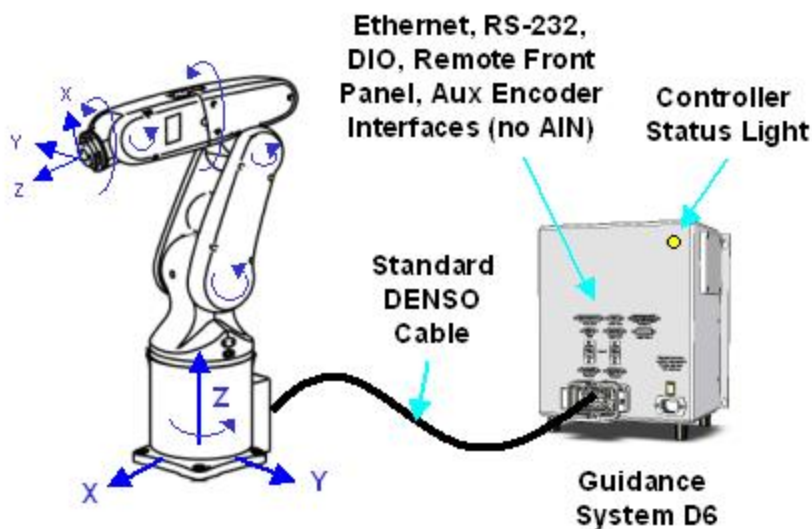

Figure 2-2: Standard DENSO 6-Axis Robot

The World and the Tool coordinate systems for this 6-axis robot as well as the positive direction of rotation for each of the robot's rotary axes are shown in [Figure 2-2](#). When the axes are at their 0 positions (not illustrated), the first joint will be in the middle of its range of travel, the major axis of the inner and outer links will be vertical, the Tool Z-axis will be pointed in the positive World Z-direction, and the 4th axis and the Theta will be at the middle of their ranges of travel.

With regard to the general capabilities of both the D4 and D6, the system is compatible with a standard DENSO mechanism and can connect to the mechanism's motors and encoders utilizing an off-the-shelf robot cable provided by DENSO Robotics.

In addition to the motion interface, the Guidance System includes extensive communication interfaces:

- Two 10/100 Mbps Ethernet ports, a RS-232 serial interface
- Twelve digital input and eight digital output signal channels
- An interface for a remote front panel
- An additional eight digital input and eight digital output channels that are typically used for gripper control signals.

Optional integrated hardware is available that provides two or four analog inputs (not available on the D6), auxiliary encoder interfaces that can be used for conveyor belt encoders, and DC power for a camera and its light source.

An Ethernet port can be connected to a PC to enable access to the web-based GUI or to permit a PC application to provide real-time commands to the Guidance System. Alternately, the Ethernet ports can interface to Ethernet cameras, an Ethernet Remote I/O module that provides additional communications facilities, or other PreciseFlex controllers.

The remote front panel interface contains all of the signals necessary to implement a fully compliant EC Category 3 (CAT-3) remote operator control panel. This interface includes redundant E-Stop inputs, a second RS-232 port to connect to a hardware Manual Control Pendant (MCP), and all other required safety signals. If a full Category 3 (CAT-3) operator panel is not required, a PreciseFlex MCP or E-Stop box can be directly connected to this interface.

A yellow Controller Status Light is mounted at the top front face of the enclosure and blinks once per second to indicate that the controller is operational or at four times a second when power is being supplied to the mechanism's motors.

System Components

Major Components

The Guidance System D4 is pictured in [Figure 2-3](#). All of the interface connectors, switches, and lights are on the front surface of the enclosure. This permits the unit to be mounted on a panel using the screw holes that are on the right and left mounting flanges.

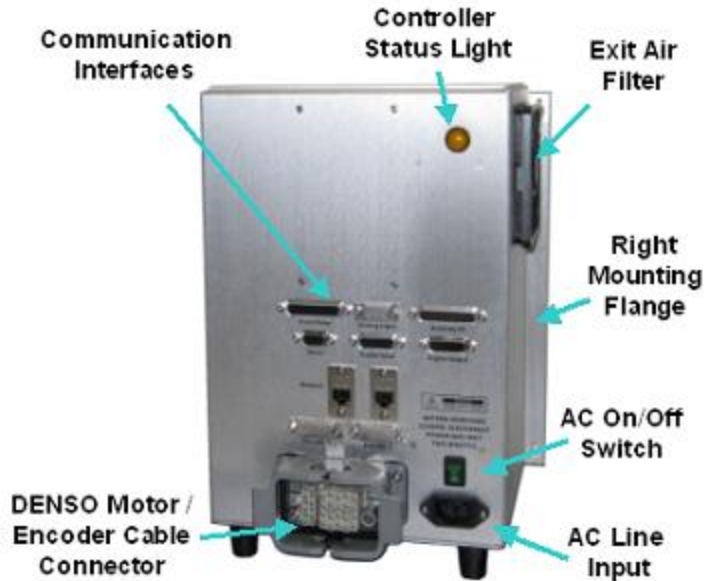

Figure 2-3: Guidance System D4

The general Communication Interfaces include:

- Connectors for Ethernet
- RS-232 serial I/O
- Digital input and output signals
- A remote front panel / MCP / E-Stop interface
- Auxiliary digital I/O for gripper control
- Special valve control signals
- Optional analog input signals (not available on the D6)
- Optional auxiliary encoder inputs

The robot's motors and encoders are connected via a special connector that conforms to DENSO's standard robot cable. To the right of this connector is a backlit AC On/Off switch and a standard IEC connector for plugging in the AC mains power cord. In the top right is a yellow Controller Status Light that blinks slowly when the controller is operating or quickly when motor power is enabled.

The Guidance System D6 is pictured below in [Figure 2-4](#). This system is very similar to the D4. The primary differences are that the enclosure is slightly wider and deeper, the unit includes two additional motor drives, and the optional analog input is not available.



Figure 2-4: Guidance System D6

The interior of the Guidance System is shown in [Figure 2-5](#), with its top cover and back panel detached and the cables removed. This illustrates the mounting of the major components:

- Guidance Controller
- Guidance G0200C Slave Amplifier (D6 only)
- 24VDC logic power supply
- PrecisePower 300/600 Intelligent Motor Power Supply
- Auxiliary I/O Board
- Valve Control Board

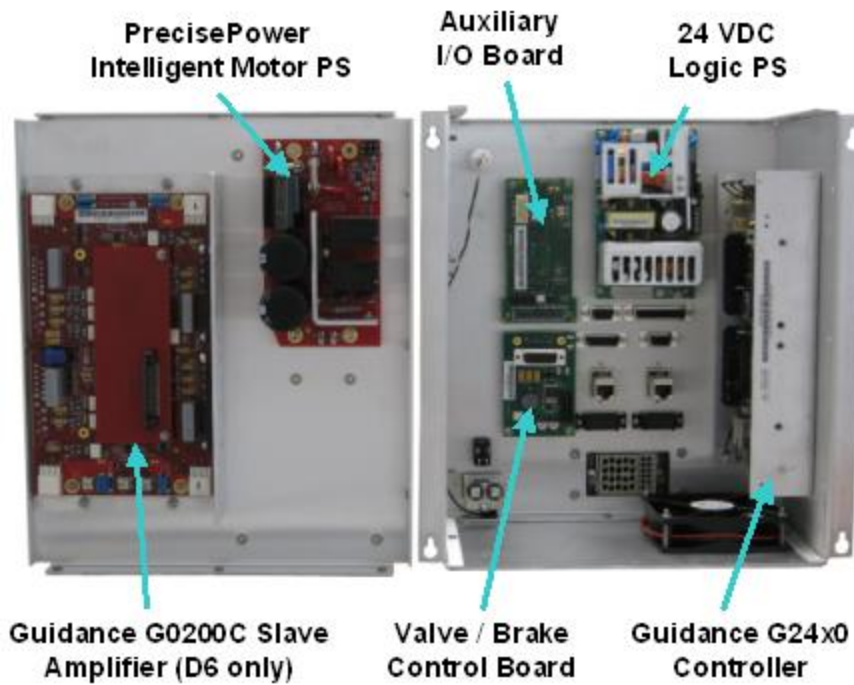



Figure 2-5: Guidance System Interior



 DANGER Electrical Shock	
<p>The Guidance Controller, Guidance Slave Amplifier, the PrecisePower Intelligent Motor Power Supply, and the 24VDC logic power supply are open frame electrical devices that have exposed unshielded high voltage pins, components and surfaces. In addition, the motor supply provides 320VDC volts and takes about two minutes to bleed down after power is disconnected. AC power to the system must be disconnected for 2 minutes prior to removal of the covers or the back panel.</p>	

Guidance 24x0 Controller

Depending upon the specific DENSO mechanism model that is to be controlled and the selected interface options, the Guidance System includes one of several different types of PreciseFlex Guidance 24x0 Controllers. The G2410 has 10A peak current motor drives whereas the G2420 is equipped with 20A peak current motor drives. Both units support a number of versions of the processor and communication boards that offer different communication interfaces. Nonetheless, these controllers all have the same footprint and provide the same set of extensive software features. The Guidance 24x0 Controller is shown below in [Figure 2-6](#).



Figure 2-6: Guidance 24x0 Controller

 DANGER Electrical Shock	
<p>The Guidance Controller is an open frame electrical device that has exposed unshielded high voltage pins, components and surfaces.</p> <p>AC power to the system must be disconnected prior to removal of the enclosure covers or back panel.</p>	

The Guidance 24x0 Controller is a 4-axis general-purpose motion controller that contains four motor drives and eight encoder input channels. One of the encoder inputs is interfaced to the daisy-chained DENSO motor encoders. Up to four of the remaining encoder inputs are optionally available on the enclosure front panel. Typically, these additional encoder inputs are utilized for reading the position of a conveyor belt to implement conveyor tracking. Normally, incremental encoders are connected to conveyor belts, but the controller supports a variety of absolute encoders (e.g. Yaskawa Sigma II/III, Panasonic A4, Tamagawa SA35-17/33Bit-LPS and certain Bosch models) as well as analog sinusoidal encoders.

The controller's standard input and output capabilities include:

- Twelve optically isolated digital input channels
- Eight optically isolated digital output channels
- 0, 2, or 4 +/- 10VDC analog input channels
- An RS-232 serial port
- Two Ethernet ports

In addition, the controller has a Remote Front Panel interface that provides dual E-Stop inputs and a second RS-232 line for communicating with a hardware manual control pendant.

For the Guidance Controller to operate correctly, it must be attached to a heat sink and properly cooled. In the Guidance System, the heat sink is provided by the sheet metal enclosure and additional cooling is generated by an internal fan.

For detailed information on the controller including additional information on its interfaces, see the *Guidance 3000/2000 Controllers, Hardware Introduction and Reference Manual*.

Guidance 0200 Slave Amplifier (D6 only)

The primary functional difference between the D4 and the D6 systems is that the D6 includes a Guidance 0200 Slave Amplifier that is mounted on the back panel of the enclosure. This amplifier provides two additional 10A peak current motor drives that control the 5th and 6th axes of the robot. This slave unit is connected to the Guidance 24x0C controller via a ribbon cable. The combination of these two units is illustrated in [Figure 2-7](#).

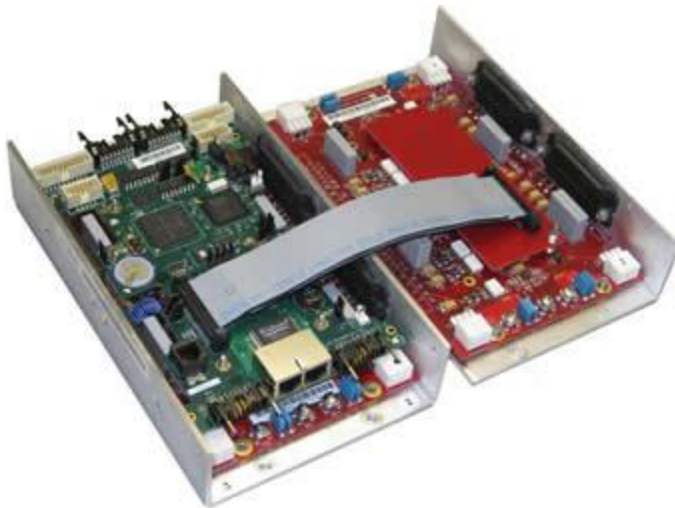



Figure 2-7: Guidance 0200 Slave Amplifier

 DANGER Electrical Shock	
<p>The Guidance Controller and the Slave Amplifier are open frame electrical devices that have exposed unshielded high voltage pins, components and surfaces.</p> <p>AC power to the system must be disconnected prior to removal of the enclosure covers or back panel.</p>	

Even when this Slave Amplifier is present, all of the primary communication interfaces are provided by the Guidance 24x0C controller including the electrical interfaces to the robot's encoders. The only connections to the Slave Amplifier are the communication ribbon cable to the Guidance 24x0C controller, output interfaces to drive the motors, and DC power inputs.

For the Guidance 0200C to operate correctly, it must be attached to a heat sink and properly cooled. In the Guidance System, the heat sink is provided by the sheet metal enclosure and additional cooling is generated by an internal fan.

For detailed information on the Slave Amplifier, see the *"Guidance 3000/2000 Controllers, Hardware Introduction and Reference Manual."*

Low-Voltage Power Supply

The Guidance Controller requires 0.7 Amps of 24VDC power for its logic circuits and 2 Amps for IO power, for a total of 2.7 Amps. For applications using remote IO or Ethernet cameras, Brooks recommends a total of 5 Amps. Within the Guidance System, this requirement is met by an internally mounted 125-Watt, 24VDC Power Supply (shown in [Figure 2-8](#)) that accepts AC input from 90V to 264V.

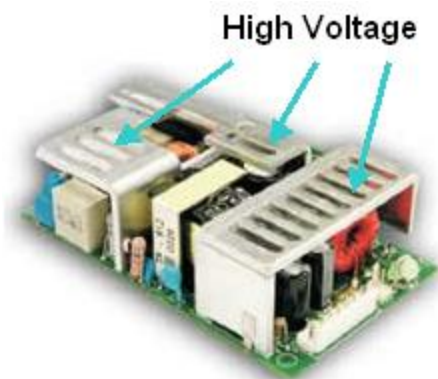



Figure 2-8: 125-watt, 24 VDC Power Supply

 DANGER Electrical Shock	
<p>The 24VDC logic power supply is an open frame electrical device that has exposed unshielded high voltage pins, components and surfaces.</p> <p>In addition, the heat sinks on the 24VDC Power Supply are not grounded and expose high voltage levels. AC power to the system must be disconnected prior to removal of the enclosure covers or back panel.</p>	



Intelligent Motor Power Supply

The Guidance Controllers and Slave Amplifier can accept motor power from 24VDC to 340VDC. Built into the Guidance System is a 300/600 Watt PrecisePower Intelligent Motor Power Supply (shown below in [Figure 2-9](#)). This unit operates with input voltages from 90 to 264 VAC 50/60Hz and generates a nominal output of 160VDC or 320VDC depending upon the input voltage.

NOTE: For DENSO robot models that require over 300 Watts of power, the system should be attached to a single-phase line voltage of 220 VAC in order to generate 600 Watts of output power.

This intelligent power supply includes:

- A single relay for enabling and disabling motor power when commanded by the controller
- Built-in fuses
- Large value output filter capacitors to store deceleration energy for use when power is needed
- The ability to absorb line spikes

 DANGER Electrical Shock	
<p>The PrecisePower Intelligent Motor Power Supply is an open frame electrical device that has exposed unshielded high voltage pins, components and surfaces. In addition, the power supply provides 160 VDC to 320 VDC volts and takes about two minutes to bleed down after power is disconnected.</p> <p>AC power to the system must be disconnected prior to removal of the enclosure covers or back panel.</p>	

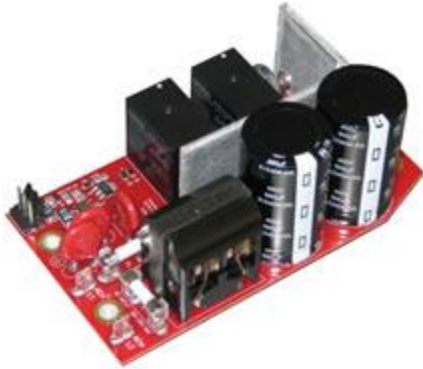

Figure 2-9: 300/600 Watt PrecisePower Intelligent Motor Power Supply

Valve/Brake Control Board

Installed within each Guidance System D4/D6 is a Valve/Brake Control Board, shown in [Figure 2-10](#). This board passes through all eight built-in digital output signals from the Guidance Controller to the front of the control system. In addition, the last two outputs are converted to special valve control signals that are available in the same connector as the standard outputs.

These special signals can be turned on and off under software control in the same manner as other outputs. However, each time these valve signals are turned on, their output voltage is driven at 24VDC for 0.5 msec after which time the signal automatically drops to 3.9VDC for the duration of the period that the signal is asserted. This initial high voltage is important to quickly actuate certain types of valves. However, for some valves, if the voltage were to remain high for too long a period, the valve would overheat and be damaged.

This board also has a circuit that converts the brake release signal generated by the Guidance Controller into a signal that is compatible with the DENSO robot.



 WARNING	
<p>This board contains unshielded 24VDC signals and pins. This assembly is designed to be mounted in a cabinet or machine chassis that is not accessible when power is turned on.</p>	



Figure 2-10: Valve/Brake Control Board

Auxiliary Digital I/O Board

The Guidance System D4/D6 includes an Auxiliary Digital I/O Board, shown in [Figure 2-11](#). This unit provides an additional eight general purpose optically isolated digital input signals and eight general purpose optically isolated digital output signals. These signals have a somewhat slower response time than the signals provided directly by the Guidance Controller. Nonetheless, these additional input and output signals are often very useful for interfacing to tooling, grippers and sensors mounted on the end of the robot or for other general application needs. These auxiliary DIO signals are often connected to the DENSO "end-effector control signals" that are routed from a connector at the base of the robot straight through to an equivalent connector that is provided close to the last axis of the robot.

This integrated board can also provide power for an Ethernet camera and a ring light, and can blink the system's Controller Status Light.



 WARNING	
<p>This board contains unshielded 24VDC signals and pins. This assembly is intended to be mounted in a cabinet or machine chassis that is not accessible when power is turned on.</p>	



Figure 2-11: Auxiliary Digital I/O Board

Remote Front Panel, E-Stop Box and Manual Control Pendant

To have a hardware E-Stop button, PreciseFlex offers an E-Stop Box or a portable Hardware Manual Control Pendant that includes an E-Stop button (shown in [Figure 2-12](#)). For those applications where an operator must be inside the working volume of the robot while teaching, a second teach pendant with a three-position hold-to-run button is also available. Any of these units can be plugged directly into the Remote Front Panel connector located on the front of the Guidance System. Each of these units provides the hardware signals to permit power to be enabled and disabled.

In the future, Brooks plans to offer a remote front panel that will contain a high power enable button, an auto/manual keyed selector switch, an E-Stop button, and a back panel connector for user E-Stops and interlocks.



Figure 2-12: Hardware Manual Control Pendant with an E-Stop button

NOTE: To enable motor power without an E-Stop Box, Hardware Manual Control Pendant or remote front panel, the jumper plug supplied with the system (pictured below in [Figure 2-13](#)) must be installed in the 25-pin Remote Front Panel connector.

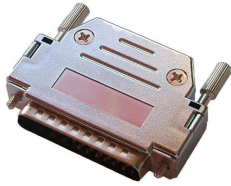

Figure 2-13: Jumper Plug

For additional information on the signals provided on the Remote Front Panel connector, see ["Hardware Reference" on page 42](#).

Remote IO Module

For applications that require additional IO capability beyond the standard functions provided with the Guidance System, a PreciseFlex Remote IO (RIO) module may be purchased. The RIO is designed to be remotely mounted and requires 24VDC for its logic power. This device can be positioned any where within the Guidance System's network and communicates via 10/100 Mb Ethernet. Up to four RIOs can be connected to a controller.

The basic RIO includes:

- 32 isolated digital input signals
- 32 isolated digital output signals
- One RS-232 serial line

An enhanced version of the RIO, shown in [Figure 2-14](#), adds four analog input signals, a second RS-232 port, and one RS-422/485 serial port. In addition, expansion boards will soon be offered that cost effectively add additional isolated digital inputs and outputs in groups of 32 each to the basic RIO.



 WARNING	
<p>The RIO contains unshielded 24VDC signals and pins. This product is intended to be mounted in a cabinet or machine chassis that is not accessible when power is turned on.</p>	



Figure 2-14: Enhanced RIO module

Machine Vision Software and Cameras

All Guidance Systems support the PreciseVision machine vision system. This is a vision software package that can run either on a PC for higher performance applications, or in the motion controller processor for simple applications (available in the future).

When PreciseVision is executed on a PC, it communicates with the motion controller via Ethernet and with cameras via either Ethernet or USB connections. Vendors such as IDS Imaging offer a variety of Ethernet machine vision cameras and industrial USB cameras.

Controller Status Light

The system includes a yellow Status Light that is mounted on the top front face of the enclosure. This light blinks to indicate the execution state of the controller.

If the Status Light is not visible for any reason, a general purpose digital output can be assigned to blink in synchronization with the Status Light. To configure a digital output, the "Power State DOUT" (DataID 235) must be set equal to the signal's channel number.

The execution conditions that are indicated by this light and an output signal (if configured) are described in [Table 2-1](#).



Table 2-1: Light and System Status

Status Light	System Status	Description
Continuously Off	(1) Logic power off or (2) CPU crashed	Normally indicates that 24VDC logic power is off. In rare instances, indicates that the controller has crashed due to a system hardware or software error. The processor may be executing the firmware debugger, dBug.
Continuously On	(1) Booting or (2) CPU crashed	Typically indicates that 24VDC logic power is on and the controller is executing its startup boot sequence. If the light turns on continuously after it has been blinking, the processor has crashed due to a system hardware or software error. The processor may be executing the firmware debugger, dBug.
Blinks one time per second	Normal operation, motor power off	The controller is executing in its standard operating mode and motor power is disabled.
Blinks four times per second	Normal operation, motor power on	The controller is executing in its standard operating mode and motor power is enabled.
Blinks eight times per second	CPU overheating	The processor is overheating, motor power is off and the user has five minutes to save any programs or data. After five minutes, the processor will shut down and needs to be rebooted.

Machine Safety

Voltage and Power Considerations

The Guidance 24x0 requires two DC power supplies: a 24VDC power supply for the processor and user IO, and a separate motor power supply. The motor power supply must provide the controller with a voltage between 24VDC and 340VDC.

 DANGER Electrical Shock	
<p>The Guidance 24x0, the Guidance Slave Amplifier, the PrecisePower 300/600 Intelligent Motor Power Supply, and the 24VDC power supply are all open frame electrical devices that contain unshielded high voltage pins, components and surfaces. These products are intended to be mounted in a cabinet or machine chassis that is not accessible when AC line power is turned on. In the Guidance System, these units are mounted within the enclosure.</p>	



The Guidance System includes a 300/600-Watt PrecisePower Intelligent Motor Power Supply that has an input range of 90 to 264 VAC 50/60 Hz and a nominal output of 160VDC to 320VDC depending upon the AC input. This motor power supply contains a relay that permits the controller to enable and disable motor power.

The PrecisePower Intelligent Motor Power Supply limits inrush current to 6 Amps. It is protected against voltage surge to 2000 Volts by means of MOV's at the line input. Transient over voltage (< 50 μ s) may not exceed 2000V phase to ground, as per EN61800-31996. It is protected against over current by two 6.3 Amps, 250V fuses, Wickman PN 1941630000.

The PreciseFlex controller can monitor motor power through its datalogging function. Intermittent power dropouts can be detected by setting a trigger in the data logger which can record and time-stamp power fluctuations.

Guidance System Enclosure

In the Guidance System D4/D6, the Guidance 24x0 controller, the Guidance Slave Amplifier, and their power supplies are mounted within an enclosure, shown in [Figure 2-15](#). This enclosure includes a top and bottom cover and a back panel. These covers and the back panel must be in place whenever power is applied to the control system.

 DANGER Electrical Shock	
<p>The surfaces, connectors, and leads pictured in the red amp board (below in Figure 2-16) and the labels indicate exposed elements of the Guidance 24x0 controller and the Guidance 0200C Slave Amplifier that carry motor power signals. These signal levels are at voltages of up to 320 VDC.</p>	

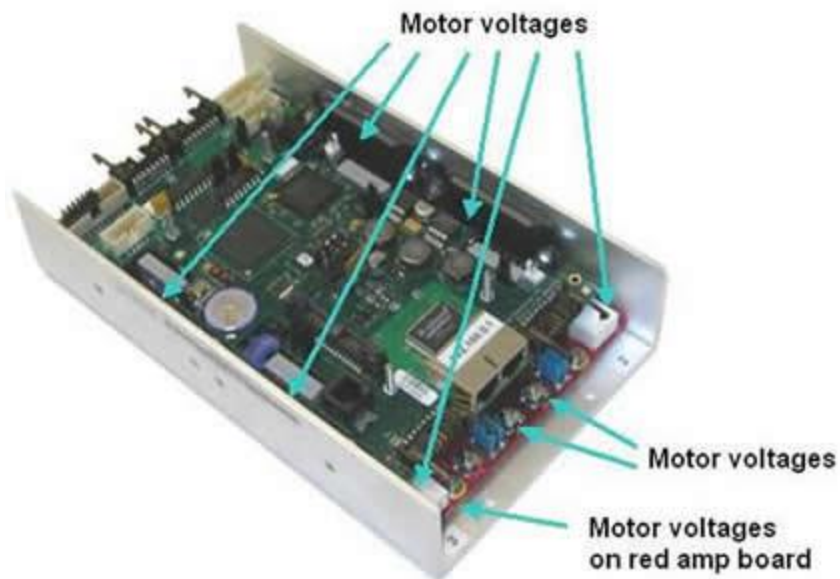



Figure 2-15: Guidance System Enclosure

 DANGER Electrical Shock	
<p>The PrecisePower Intelligent Motor Power Supply is an open frame supply that provides 160VDC to 320VDC volts and takes about two minutes to bleed down after power is disconnected. The 24VDC power supply is also an open frame supply with exposed high voltage terminals. The control system should not be operated without the covers and back panel installed.</p>	

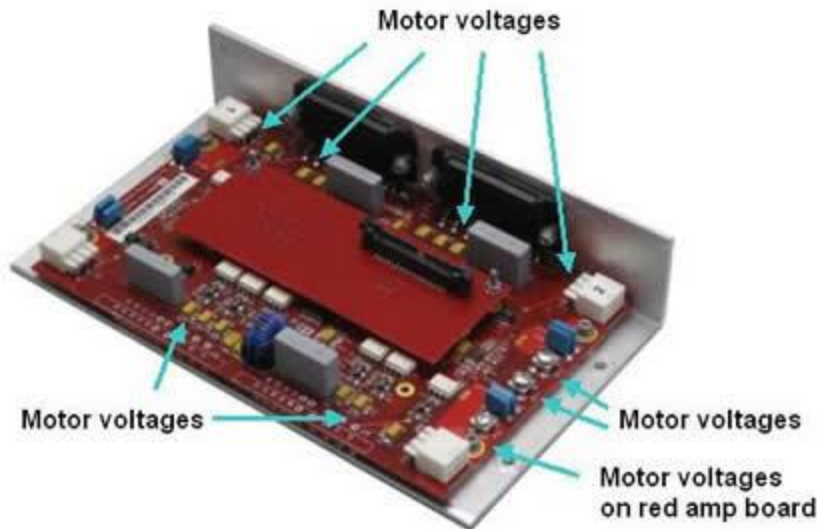

Figure 2-16: High Voltages

Releasing a Trapped Operator: Brake Release Switch

If the DENSO robot that is interfaced to the Guidance System has one or more axes with brakes, when a hard E-Stop is triggered, the brake(s) will engage and motor power will be disconnected from all motors. For axes that do not have brakes, they may be manually repositioned by pushing on each axis. However, to move axes with brakes, the operator must release the brakes by clicking the brake release button that is typically mounted at the top of the robot. This will release all brakes so long as the main AC power to the Guidance System is enabled.

Mechanical Limit Stops

If an axis of the DENSO mechanism is equipped with a mechanical moveable limit stop and the position of the stop is changed, it is important that the software "Soft stop limit" and "Hard stop limit" settings be adjusted to be inside of the new mechanical restrictions. The software limit stop values can be modified by a user with administrator privileges to the robot. To modify the software limits, the robot motor power must be disabled first. Then, the software limits may be adjusted and saved to flash memory.

E-Stop Stopping Time and Distance

The control system responds to two types of E-Stops.

Soft E-Stop

A “Soft E-Stop” initiates a rapid deceleration of all robots currently in motion and generates an error condition for all programs that are attached to a robot. This method can be used to quickly halt all robot motions in a controlled fashion when an error is detected.

This function is similar to a “Hard E-Stop” except that a soft E-Stop leaves motor power enabled and is therefore applicable to less severe error conditions. Leaving motor power enabled is beneficial in that it prevents the robot axes from sagging and does not require motor power to be re-enabled before program execution and robot motions are resumed. This method is similar to a “Rapid Deceleration” except that a rapid deceleration only affects a single robot and no program error is generated.

Hard E-Stop

A “Hard E-Stop” is generated by one of several hardware E-Stop inputs and causes motor power to be disabled. However, there is a firmware parameter that can delay opening the motor power supply relay for a fixed amount of time after a hard E-Stop signal is asserted. This delay is nominally set at 0.5 seconds and may be adjusted by an operator with administrator privileges. On the web-based operator interface menu, go to **Setup**→**Parameter Database**→**Controller**→**Operating Mode** and set parameter DataID 267 to the desired delay. If this delay is set to 0, the motor power relay will be disabled within 1ms after an input signal is asserted.

If an axis does not have a mechanical brake and motor power is disabled while the axis is moving, it may coast for a significant distance. Leaving the motor power enabled for 0.5 seconds allows the servos to perform a rapid controlled deceleration of these axes. For example, if a linear axis is moving at a speed of 1000 mm/sec and the servos decelerate it at 0.4G (3920 mm/sec²), the axis will reach a full stop in 0.26 sec after having only traveled a distance of 127 mm.

If a gravity loaded axis does have a mechanical brake but the brake takes some time to engage, if motor power is disabled immediately when a hard E-Stop is signaled, the axis will drop before the brake takes effect. In this case, delaying for a short period of time before disabling motor power allows time for the brake to engage and prevents the axis from dropping.

Safety Zones

For all robot types, “Safety Zones” can be defined that disable motor power and halt the motion of the robot if its tool center point (TCP) violates the requirements of a user defined 3D volume.

Types of Safety Zones

These 3D safety zones can be used to:

1. Approximately model the volume of stationary objects or personnel working areas to prevent the robot from inadvertently entering this volume and causing a collision (“keep out zones”).
2. Reduce the normal working volume of the robot to prevent the robot from reaching beyond prescribed boundaries and causing a collision (“stay within zones”).
3. Verify that the robot’s TCP speed (when in a specified volume) is below a specified limit so that the robot can be safely decelerated and stopped before it might pin an operator’s hand to a hard surface with too high a force (“speed restrict zones”).

As currently implemented, the “keep out zones” and “stay within zones” are provided as general safety features, but they do not meet the stringent Category 3 safety standards that require fail safe redundant logic. However, the “speed restrict zones” do provide the requisite redundancy and are in the process of being Category 3 certified. The “keep out zones” and “stay within zones” are collectively referred to as “uncertified zones” and the “speed restrict zones” are referred to as “certified zones”.

The supported zone shapes are rectangular volumes, cylinders and spheres. To define a safety zone, the type of safety zone must be specified along with its origin and dimensions.

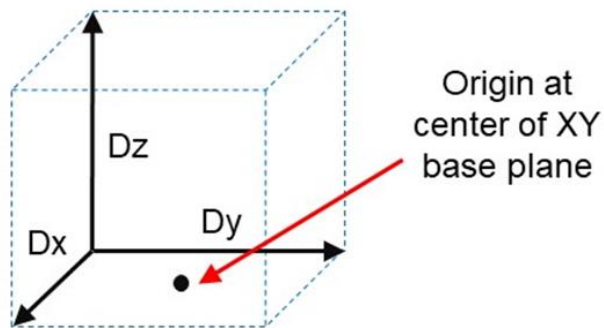

Figure 2-17: Rectangular Volume

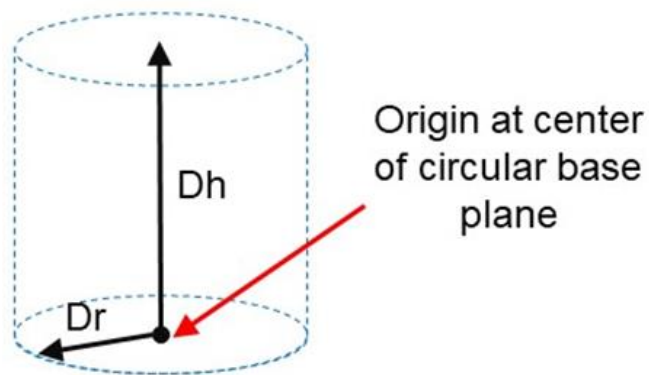

Figure 2-18: Cylinder

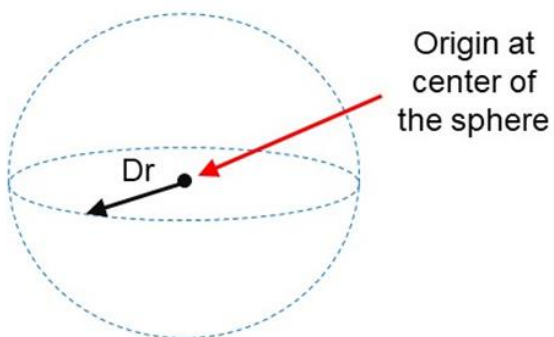

Figure 2-19: Sphere

For increased generality, uncertified zones can be arbitrarily positioned and rotated in all three dimensions. Due to implementation limitations, certified zones must be non-rotated rectangular volumes, which can be arbitrarily positioned. Up to 10 zones can be defined for each robot and any mix of certified and uncertified can be specified. Due to safety requirements, any new or modified zone specifications only go into effect after the controller is rebooted.

Safety Zone Violation Detection and Clearing

Uncertified safety zones are active in the following circumstances:

- Continuously during program-controlled motions of all types (straight line or arc Cartesian and joint interpolated).
- Continuously during manual (jog) control modes: World, Tool and Joint, but not free.
- Motion planning (final destinations only).
- Location object.KineSol method during conversions to either Cartesian or joint Locations.

Certified safety zones are only active during program-controlled motions (of all types) since this is the only circumstance where higher TCP speeds are possible.

When motor power is enabled and the robot's TCP is in violation of an uncertified safety zone, a program-controlled motion cannot be initiated. This condition can be cleared by disabling motor power and manually repositioning the robot or by manually jogging the TCP in World, Tool or Joint modes, so long as the jog motion reduces the safety zone violation distance. That is, jogging motions that increase the violation of a safety zone are not permitted.

NOTE: Safety zone testing is based on the TCP of the robot. Therefore, it is very important that the position of the tool center point relative to the robot's tool mounting flange is set correctly. Please see the Robot.Tool property for information on defining the TCP.

Certified Speed Restrict Safety Zones

While the uncertified safety zones perform conventional tests on just the position of the TCP, there are two certified safety zones and these perform special tests to detect if the speed of the TCP exceeds a limit while the TCP is within the zone. The first certified safety zone tests if the Z downward speed of the TCP exceeds a specified limit. This safety zone was implemented for the PreciseFlex 400 and PreciseFlex 3400 robots since their only intrinsically non-safe motion is a high-speed downward Z motion that could trap a person's hand between the tooltip and a fixed object or horizontal surface. The second certified safety zone tests if the horizontal, XY planar, speed of the TCP exceeds a specified limit. This test was developed for the PreciseFlex DD robots since robots can generate excessive speeds when moving horizontally.

For both of these tests, in order to satisfy the computational redundancy requirement of the Category 3 safety regulations, the shapes of these safety zones are limited to non-rotated rectangular volumes.

Please consult the user manuals for these PreciseFlex™ robots for when speed restrict safety zones must be defined to safely operate these mechanisms.

Configuring Safe Zones

Up to 10 safety zones can be defined per robot. Each of these zones is specified by filling in one of the Parameter Database IDs 16900 to 16909, which are labeled "Safety Zone: type, x/y/z/y/p/r, dim 1/2/3". Any combination of certified and uncertified safety zones can be specified. Each of these DataIDs consists of an array of 10 numbers and the first value defines the safety zone "type". Any DataID that has a zero "type" is ignored. [Table 2-2](#) describes the possible safety zone types:

Table 2-2: Safety Zone Types

Safety Zone Type	Description
0.	Undefined safety zone
1.	Rectangular volume, keep out zone
2.	Cylinder, keep out zone
3.	Sphere, keep out zone
4.	Rectangular volume, stay within zone
5.	Cylinder, stay within zone
6.	Sphere, stay within zone
7.	Non-rotated rectangular volume, Z downward speed restrict zone
8.	Non-rotated rectangular volume, XY speed restrict zone

[Table 2-3](#) describes the safety zone DataIDs. When any of these DataIDs are modified, the controller must be rebooted for the change to be put in effect.

Table 2-3: Data IDs

DataID	Parameter Name	Description
16900 to 16909	Safety Zone: type, x/y/z/y/p/r, dim 1/2/3	<p>Each safety zone definition consists of an array of 10 values. The first value is the safety zone “type”. The next six values define the position of the origin of the volume of interest and its orientation. This is specified as a standard Location value:</p> <p style="text-align: center;">x, y, z, yaw, pitch, roll.</p> <p>The final three values define the size of the volume of interest. For the permitted shapes, this is interpreted as:</p> <p style="text-align: center;">volume: Dx, Dy, Dz Cylinder: Dh, Dr, 0 Sphere: Dr, 0, 0</p> <p>For example, for a downward Z non-rotated rectangular volume speed restrict safety zone, a single DataID should be specified as follows:</p> <p style="text-align: center;">7, x, y, z, 0, 0, 0, Dx, Dy, Dz</p> <p>Where x, y, z are the coordinates of the center of the base of the rectangular volume and Dx, Dy, Dz are the dimensions of the volume, all in mm.</p>

In addition, the DataID in [Table 2-4](#) must be initialized to establish the maximum speed limits for the certified safety zones:

Table 2-4: Data IDs

DataID	Parameter Name	Description
2740	Certified safety zone, max Z/XY spd mm/sec	<p>These parameters define the maximum speeds that are permitted for the Certified Speed Restrict Safety Zones. The first value is the maximum downward Z speed (when within the safety zone) in mm/sec. Since this is a downward speed, it should be a negative value and defaults to -200. The second value is the maximum permitted speed in the horizontal XY plane (when within the safety zone), and defaults to 200 mm/sec.</p>

Safety Standards Reference Material

The Guidance System can control mechanisms that are capable of moving at high speeds and exerting considerable force. Like all robot and motion systems, and most industrial equipment, these systems must be treated with respect by the user and the operator.

This manual should be read by all personnel who operate or maintain PreciseFlex systems, or who work within or near the work cell.

Read the *American National Standard for Industrial Robot Systems – Safety Requirements*, published by the Robotic Industries Association (RIA) in cooperation with the American National Standards Institute. The publication, ANSI/RIA R15.06, contains guidelines for robot system installation, safeguarding, maintenance, testing, startup, and operator training. Also read the International Standard IEC 204 or the European Standard EN 60204, *Safety of Machinery – Electrical Equipment of Machines*, and ISO 10218 (EN 775), *Robots for Industrial Environments – Safety Requirements*, particularly if the country of use requires a CE-certified installation.

Standards Compliance and Agency Certifications

The Guidance System is intended for use with other equipment and is considered a subassembly rather than a complete piece of equipment on its own. It meets the requirements of these standards:

- EN 61000-4-2 Electrostatic Discharge (8 KV air, 6 KV contact)
- EN 61000-4-3 Radiated Electromagnetic Field Immunity (3 V/m, 27-500 MHz)
- EN 61000-4-4 Electrical Fast Transient/Burst Immunity (2 KV)
- EN 61000-4-5 Surge Immunity Test (1 KV differential, 2 KV common mode)
- EN 61000-4-6 Conducted Disturbances Immunity (RF: 150 KHz – 80 MHz)
- EN 50081-2 Electromagnetic Compatibility General Emissions Standard

To maintain compliance with the above standards the Guidance System must be installed and used in accordance with the regulations of the standards, and in accordance with the instructions in this user's guide.

In addition to the above standards, the Guidance System has been designed to comply with the following agency certification requirements:

- CE
- CSA
- UL
- ANSI/RIA R15.06 Safety Standard

Moving Machine Safety

The Guidance System drives robots that can operate in Manual Control Mode, in which an operator directly controls the motion of the robot, or in Computer Control Mode, in which the robot operation is automatic. Manual Control Mode is often used to teach locations in the robot workspace. The robot's speed should be limited in Manual Control Mode to a maximum of 250 mm per second for safety as required by EN ISO 10218-1-2007.

This speed setting can be easily confirmed using the "Virtual Pendant" in the Web interface. After enabling power and homing the robot, select "Virtual Pendant" in the Web Control Panels Menu, then select a manual control mode such as **World Mode**, select the **X-axis**, set the speed slider to 100%, drive the axis 250 mm, and time the motion. While it is possible to set a high manual control speed, this is not recommended, and should only be done after an application risk assessment.

While some light-duty robots can only apply moderate forces, it is always very important for operators to keep their hands, arms and especially their head out of the robot's operating volume.

In Computer Mode, robots can achieve speeds of 2000 mm per second or even greater. During Computer Mode Operation it is strongly recommended that operators be prevented from entering the robot work volume by safety barriers that are interlocked to the E-Stop circuitry. Read the *ANSI/RIA R15.06 Safety Standard for Industrial Robots* or EN ISO 10218-2-2007, *Robots for Industrial Environments, Safety Requirements* for information on recommended safe operating practices and enclosure design for robots of various sizes and payloads.

3. Installation Information

Mounting and Airflow

The Guidance System is compact and has been designed to be easy mounted on a vertical surface or on the back panel within a standard enclosure or it can be placed upon a tabletop. To facilitate mounting this unit on a vertical panel, there are four holes in the right and left flanges on the back of the enclosure. These holes have been designed for use with M4 screws. The locations of these holes are indicated in the Guidance System D4, as shown in [Figure 3-1](#).

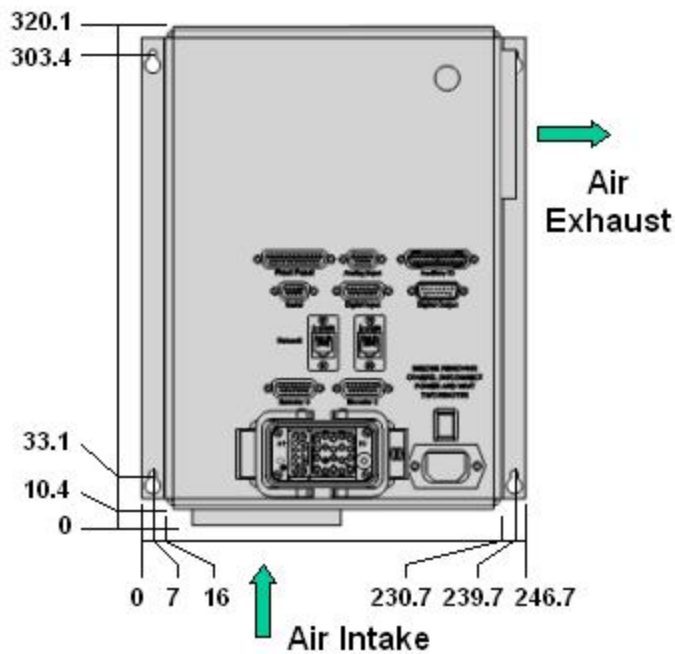

Figure 3-1: Guidance System D4, Mounting Holes

To access any of the components within the enclosure, the system must first be detached, if it is mounted on a panel, before the covers and back panel can be removed.



 DANGER Electrical Shock	
<p>The Guidance Controller, the Guidance Slave Amplifier, the PrecisePower Intelligent Motor Power Supply, and the 24VDC logic power supply are open frame electrical devices that have exposed unshielded high voltage pins, components and surfaces. In addition, the motor power supply provides 320VDC volts and takes about two minutes to bleed down after power is disconnected.</p> <p>AC power to the system must be disconnected prior to removal of the covers or back panel.</p>	

Figure 3-2 shows the equivalent drawing for the Guidance System D6.

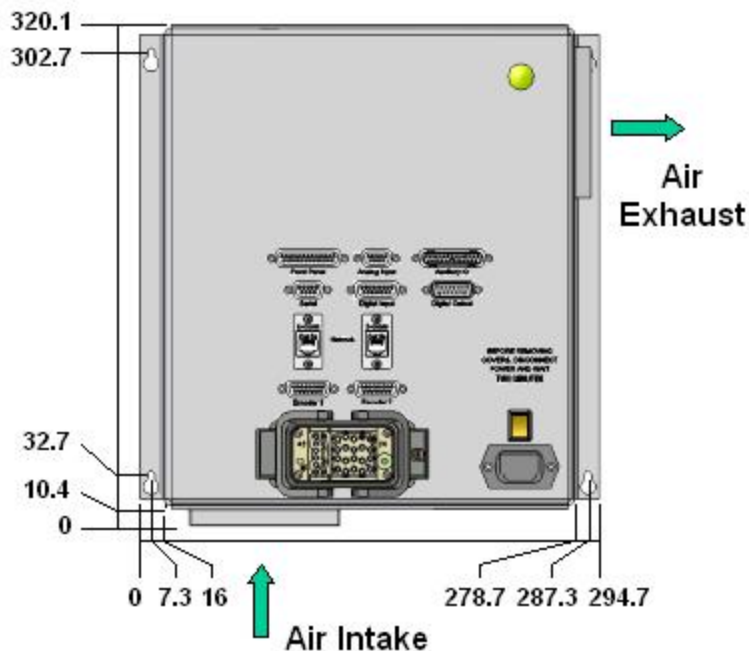

Figure 3-2: Guidance System D6, Mounting Holes

In the Guidance System, the enclosure serves as a heat sink for the controller, slave amplifier and the power supplies. Also, to provide additional cooling, this system includes an internal fan with filters. For the cooling system to operate properly, the air intake and exhaust vents in the bottom and right of the enclosure must be kept clear and ambient air must freely flow below the system. If the Guidance System is placed on a table or other surface that could restrict air flow, standoffs should be added below the unit to ensure unobstructed air flow.

4. Hardware Reference

System Interface Panel

In addition to providing the interfaces to the DENSO mechanism's motors and encoders, the Guidance System provides extensive communication services. The connectors for each of these interfaces are described in detail in this section. The list of the provided functionality is as follows:

- [Auxiliary digital IO and camera power](#)
- [DENSO motor/encoder/brake connector](#)
- [Digital input signals](#)
- [Digital output signals with valve control](#)
- [Ethernet ports](#)
- [Optional analog input channels](#)
- [Optional auxiliary encoder interfaces](#)
- [Remote front panel / MCP / E-Stop](#)
- [RS-232 serial port](#)

To simplify mounting and cabling the Guidance System, all of the interface connectors are provided on the front surface of the enclosure in an "Interface Panel," as shown in [Figure 4-1](#).

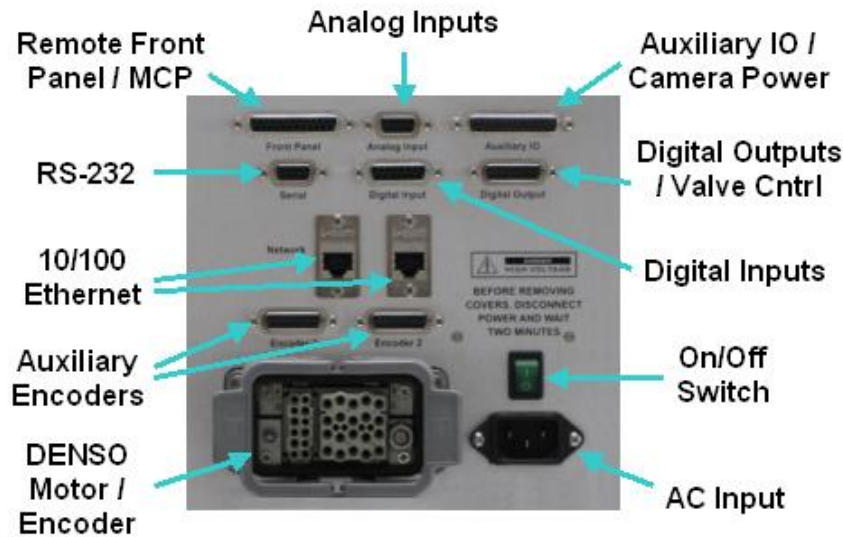

Figure 4-1: Interface Panel

This image illustrates the connectors, plugs, and switches that are contained on this panel. To jump to the detailed information for a specific interface, click on the connector's name or the connector in the picture.

Auxiliary Digital IO And Camera Power

The Auxiliary Digital IO board provides eight general purpose optically isolated digital input signals and eight general purpose optically isolated digital output signals. While these additional signals can be used for any purpose, they are often wired to the base of the DENSO robot to the "end effector control signal" connector. This connector routes the signals to close to the end effector of the robot where they can be interfaced to the robot's tooling and gripper sensors.

This board can also be optionally configured to supply power to an Ethernet camera and a ring light. If these power lines are routed to the end effector, they can power an arm-mounted camera and its light source.

This board is internally connected to the Guidance Controller via a RS485 serial line that permits the controller to scan this board's I/O with a nominal period of 4 milliseconds. With this response time, setting output signals or reading input signals is sufficiently fast for end-effectors and end-of-arm sensors, but is not as fast as the standard digital IO signals that are provided with the controller.

The auxiliary DIO signals and the optional camera and ring light power lines are accessible via a DB25 female connector (shown in [Figure 4-2](#)) mounted on the Guidance System's Interface Panel.

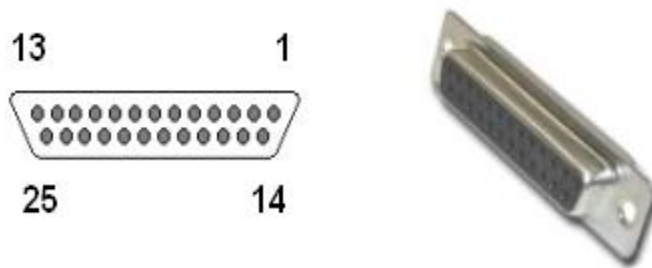

Figure 4-2: DB25 Female Connector

The eight digital input signals are configured as "sinking," as shown in [Figure 4-3](#). That is, the external equipment must provide a 5VDC to 24VDC voltage to indicate a logical high value or must allow it to float to no voltage for a logical low. For convenience, 24VDC is supplied on the DB25 connector. These inputs are compatible with "sourcing" (PNP) sensors.

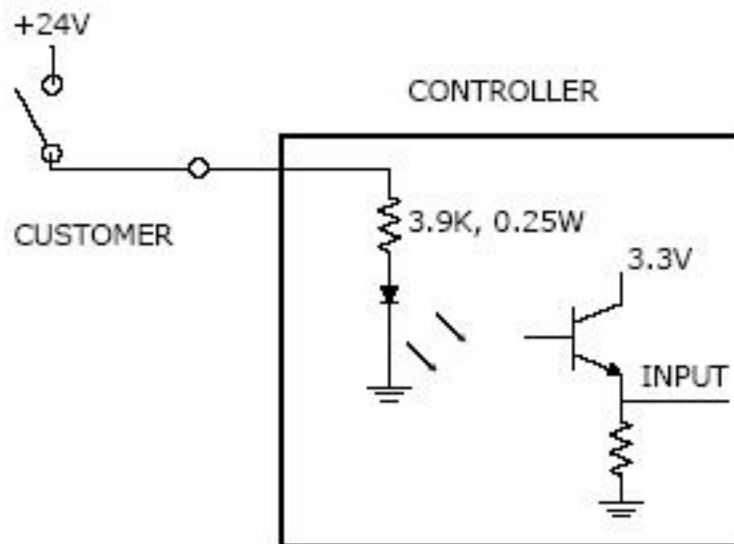

Figure 4-3: DIO Sinking Input

The eight digital output signals are configured as "sourcing," as shown in [Figure 4-4](#). That is, the external equipment must pull-down an output pin to ground and the Auxiliary IO Board pulls this pin to 24 VDC when the signal is asserted as true. Each output signal can supply a maximum of 100 mA. For convenience, ground pins are supplied on the DB25 connector. These outputs are compatible with "sinking" (NPN) devices.

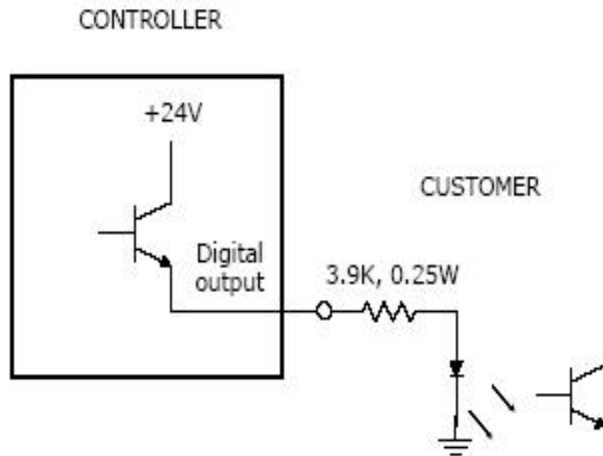

Figure 4-4: DIO Sourcing Output

The pin assignments for the DB25 connector are defined in [Table 4-1](#) along with the signal numbers used to reference these signals from GPL and the part information for the required hardware plug.

Table 4-1: DB25 Connector Pin Assignments & GPL Signal Numbers

Pin	GPL Signal Number	Description
1	33	Digital Output 1
2	35	Digital Output 3
3	37	Digital Output 5
4	39	Digital Output 7
5		Ground
6		Ground
7		24VDC
8	10033	Digital Input 1
9	10035	Digital Input 3
10	10037	Digital Input 5
11	10039	Digital Input 7
12		(Camera option) 12VDC for powering camera, 1.25A. Available whenever the controller is powered on.
13	8039	(Camera option) 9VDC for powering ring light, 1A. Enabled and disabled via a dedicated system IO signal or via the robot ZIO control panel in the Web Operator Interface.



Pin	GPL Signal Number	Description
14	34	Digital Output 2
15	36	Digital Output 4
16	38	Digital Output 6
17	40	Digital Output 8
18		Ground
19		24 VDC
20		24 VDC
21	10034	Digital Input 2
22	10036	Digital Input 4
23	10038	Digital Input 6
24	10040	Digital Input 8
25		Ground
Interface Panel Connector Part No		DB25 Female Connector
User Plug Part No		DB25 Male Plug

DENSO Motor/Encoder/Brake Connector

The Guidance System D4/D6 interfaces to all of the motors, encoders, and brakes of a DENSO mechanism via a single connector (shown in [Figure 4-5](#)) that is fully compatible with DENSO cables. Simply buy a standard DENSO robot cable with the mechanism, and plug it into this connector.



Figure 4-5: DENSO Motor/Encoder/Brake Connector

 DANGER Electrical Shock	
<p>The Motor/Encoder/Brake connector and its leads contain high voltage pins. The plug for this connector should always have its back shell properly in place and the plug should only be attached or detached to the connector when the AC line power is turned off.</p>	

The Guidance Controller contains the firmware and hardware interfaces that are necessary to properly communicate with the special absolute encoders that are employed in the DENSO robots.

When the controller is powered down, the battery that is required to retain the absolute position of each motor/encoder is built into the DENSO mechanism. Therefore, the mechanism can be disconnected from the controller without any loss of information. If the battery needs to be replaced, refer to the DENSO mechanism's maintenance manual for instructions.

Email Brooks at support_preciseflex@brooksautomation.com or contact DENSO Robotics if detailed information on the pin assignments for this motor/encoder/brake connector are required.

Digital Input Signals

The Guidance System provides 12 general purpose optically isolated digital input signals. These lines are accessed in a single DB15 connector, shown in [Figure 4-6](#).



Figure 4-6: DB15 Connector

These input signals can be configured as "sinking" or "sourcing." If an input signal is configured as "sinking" (see [Figure 4-7](#)), the external equipment must provide a 5VDC to 24VDC voltage to indicate a logical high value or must allow it to float to no voltage for a logical low. This configuration is compatible with "sourcing" (PNP) sensors.

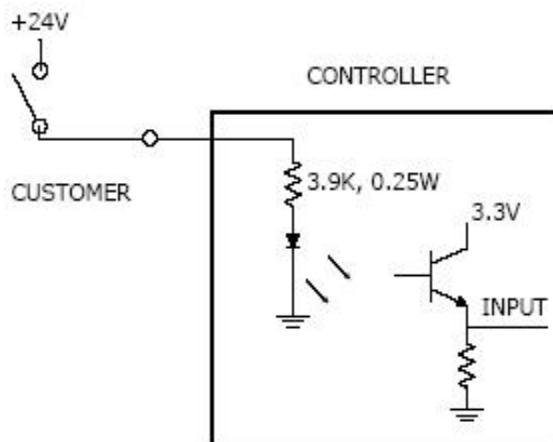

Figure 4-7: DIO Sinking Input

As shipped from the factory, the input signals are configured as "sourcing" (see [Figure 4-8](#)), i.e. the external equipment must pull a signal input pin to ground to indicate a logical high and must let the line float high to 24VDC to signal a logical low value. This configuration is compatible with "sinking" (NPN) sensors.

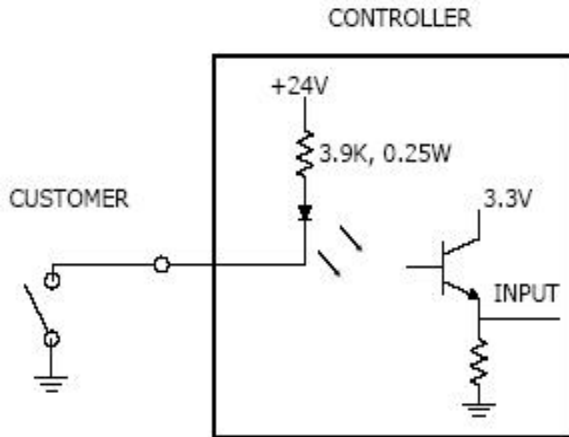

Figure 4-8: DIO Sourcing Input

Inputs can be configured as sinking or sourcing in groups of four signals. To configure groups of input signals, the covers of the enclosure must be removed and jumpers on the Guidance Controller must be changed. For more information on configuring the jumpers, see the *Guidance 3000/2000 Controllers, Hardware Introduction and Reference Manual*.

DANGER
Electrical Shock

The Guidance Controller, the Guidance Slave Amplifier, the PrecisePower Intelligent Motor Power Supply, and the 24VDC logic power supply are open frame electrical devices that have exposed unshielded high voltage pins, components and surfaces. In addition, the motor power supply provides 320VDC volts and takes about two minutes to bleed down after power is disconnected.

AC power to the system must be disconnected prior to removal of the covers or back panel.

The pin out for the Digital Input Connector and the corresponding GPL signal numbers are described in [Table 4-2](#).

Table 4-2: Pin Outs & GPL Signal Numbers

Pin	GPL Signal Number	Description
1		GND
2	10002	Digital Input 2
3	10004	Digital Input 4

Pin	GPL Signal Number	Description
4	10006	Digital Input 6
5	10008	Digital Input 8
6	10010	Digital Input 10
7	10012	Digital Input 12
8		GND
9	10001	Digital Input 1
10	10003	Digital Input 3
11	10005	Digital Input 5
12	10007	Digital Input 7
13	10009	Digital Input 9
14	10011	Digital Input 11
15		24VDC
Interface Panel Connector Part No		DB15 Female Connector
User Plug Part No		DB15 Male Plug

Digital Output Signals/Valve Control

The Guidance System provides eight general purpose optically isolated digital output signals. These outputs are accessed in a single DB15 connector (see [Figure 4-9](#)). Two of the eight signals serve a dual purpose and also control special valve signals that are provided in the same connector.



Figure 4-9: DB15 Connector

The eight general purpose output signals can be configured as "sinking" or "sourcing." As shipped from the factory, the output signals are configured as "sinking," i.e. the external equipment must provide a 5VDC to 24VDC pull-up voltage on an output pin and the controller pulls this pin to ground when the signal is asserted as true. This configuration is compatible with "sourcing" (PNP) devices.

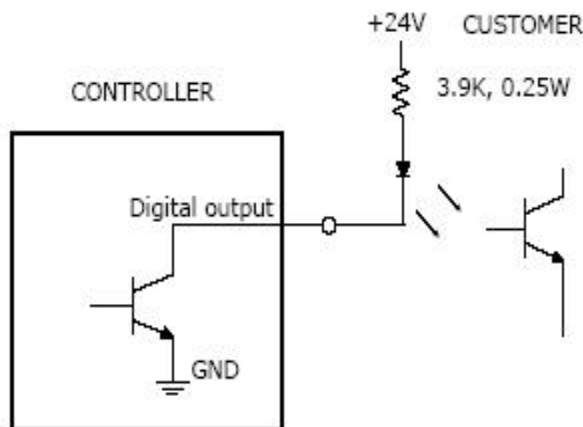

Figure 4-10: DIO Sinking Output

Alternately, the output signals can be configured as "sourcing" (see [Figure 4-11](#)), i.e. the external equipment must pull-down an output pin to ground and the controller pulls this pin to 24VDC when the signal is asserted as true. This configuration is compatible with "sinking" (NPN) devices.

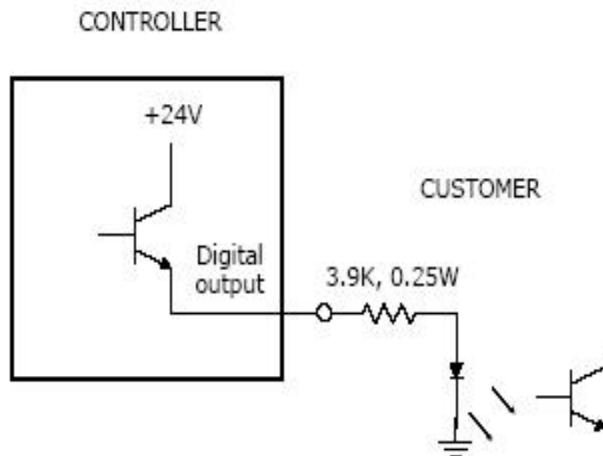



Figure 4-11: DIO Sourcing Output

Outputs can be individually configured as sinking or sourcing signals. To configure the output signals, the cover of the controller must be removed and jumpers on the Guidance Controller must be changed. For more information on configuring the jumpers, see the *Guidance 3000/2000 Controllers, Hardware Introduction and Reference Manual*.

 <b style="font-size: 1.2em; margin-left: 10px;">DANGER <b style="font-size: 0.9em; margin-left: 10px;">Electrical Shock	
<p>The Guidance Controller, the Guidance Slave Amplifier, the PrecisePower Intelligent Motor Power Supply, and the 24VDC logic power supply are open frame electrical devices that have exposed unshielded high voltage pins, components and surfaces. In addition, the motor power supply provides 320VDC volts and takes about two minutes to bleed down after power is disconnected.</p> <p>AC power to the system must be disconnected prior to removal of the cover or back panel.</p>	

The last two output signals can be utilized as standard digit output control signals. In addition, they actuate special circuits that generate valve control signals. When these valve signals are enabled, their output is driven to 24VDC for 0.5 msec (+/-10%). After this period of time, their voltage automatically drops down to 3.9VDC +/-5% and remains at that level until the output signal is disabled. This behavior is illustrated in the graph in [Figure 4-12](#).

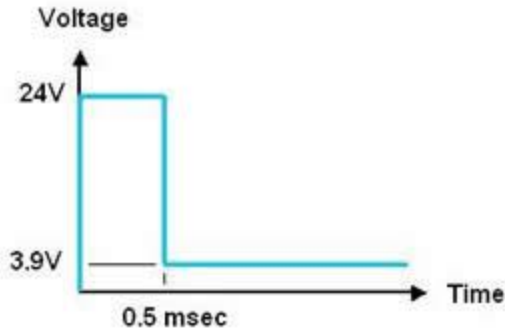

Figure 4-12: Voltage Output and Time Duration

The initial high voltage is necessary to ensure that certain types of valves quickly respond to the enable signal. However, for some valves, if the voltage remains high, the valve could overheat. Therefore, once the valve is actuated, the output drops to a low voltage that is sufficient to keep the valve opened without overheating the device. An example of this type of valve is the Lee Company's line of VHS Nanoliter Dispensing Valves.

Each of the two independent valve outputs can drive up to three valves in parallel (for a total of six valves) at a maximum frequency of 500Hz. Both valve control outputs include short circuit protection that will automatically reset after they cool down if they become too hot.

The last two general digital output signals are routed to their standard pins in the connector on the front of the enclosure. Therefore, if two independent valves are not being controlled, either one or both of the standard general outputs are still available for use. For the valve control circuits to properly operate, the last two general digital output signals must be configured as "sourcing."

As another option, if the Guidance System is not equipped with an Auxiliary Digital IO board (ZIO) or a Guidance Slave Board (GSB), the yellow controller status light that is mounted on the front of the enclosure can be driven by the eighth general digital output signal. If this general IO signal is needed for other control functions, the blinking function can be disabled by setting the Parameter Database value "Power State DOUT" (DataID 235) to 0. The following table illustrates the possible configurations for driving the status light and the corresponding setting of DataID 235.

Table 4-3: Configurations for Driving the Status Light & Setting DataID 235

Configuration	DataID 235	Description
Auxiliary Digital IO (ZIO) installed	8040	The status output of the ZIO board is connected to the status light. This is the standard configuration.
Guidance Slave Board (GSB) installed	200015	Output 3 of the GSB board is connected to the status light.
No ZIO or GSB board, DIO #8 used	20	General Digital Output 8 of the controller is connected to the status light.

Configuration	DataID 235	Description
No status light	0	There is no ZIO or GSB board installed and General Digital Output 8 is needed to operate valve 2 or some other equipment.

Table 4-4: Pin Outs for Digital Output Connector & GPL Signal Numbers

Pin	GPL Signal Number	Description
1	13	Digital Output 1 - When configured as sourcing, this output can drive 500mA, whereas Outputs 2-8 drive 100mA. As of 2013, jumpers were added to the controller to permit this signal to drive 500mA or 100mA. By default, this signal is jumpered for 100mA. Prior to 2013, this output always drove 500mA. If this output is configured for 500mA current, even when this output is off, a small amount of current leaks. This leakage can cause some devices that are connected to this signal to always indicate that this output is on. If this occurs, a small drainage resistor should be tied to this signal.
2	15	Digital Output 3
3		24VDC
4	17	Digital Output 5
5	19	Digital Output 7 (Optionally used to operate Valve 1)
6		Not used
7		(Valve Control) Valve 1-
8		(Valve Control) Valve 2-
9	14	Digital Output 2
10	16	Digital Output 4
11		GND
12	18	Digital Output 6
13	20	Digital Output 8 (If an Auxiliary Digital IO board (ZIO) or a Guidance Slave Board (GSB) is not installed, this signal controls the yellow blinking light mounted on the front of the controller and must be configured as a sinking signal. Alternately, used to operate Valve 2.)
14	[19]	(Valve Control) Valve 1+, operated by Digital Output 7
15	[20]	(Valve Control) Valve 2+, operated by Digital Output 8

Pin	GPL Signal Number	Description
Interface Panel Connector Part No		DB15 Female Connector
User Plug Part No		DB15 Male Plug

Ethernet Interface

The embedded Guidance Controller has a built-in Ethernet switch that fully implements two 10/100 Mbit Ethernet ports. This capability was designed to permit the system to be interfaced to multiple Ethernet devices such as other PreciseFlex controllers, remote I/O units, and Ethernet cameras. The Ethernet switch automatically detects the sense of each connection, so either straight-thru or cross-over cables can be used to connect the controller to any Ethernet device.

The front of the control system includes two standard RJ45 connectors (see [Figure 4-13](#)) that provide access to the Ethernet ports.



Figure 4-13: RJ45 Connector and Ethernet Plug

Either Ethernet port can be used to interface to the Guidance System. If the two ports are connected to external equipment that are communicating with each other but not the controller, the switch automatically routes the traffic between the two ports and does not send this information to the controller. For example, if an Ethernet camera is connected to one port and a PC is connected to the other port, the camera image data will not burden the controller's CPU.

See the *Setup and Operation Quick Start Guide* for instructions on setting the IP address for the controller.

Optional Analog Input Signals

The Guidance System D4 (but not the D6) can optionally provide two or four general-purpose analog input channels. If present, these signals are conveyed through a single DB9 connector (see [Figure 4-14](#)).

The Analog to Digital Converter has a 12-bit resolution and a conversion delay of 3.2 microseconds per channel. The ADC channels are continuously scanned in sequence, so a new reading is available for each channel every 6.4 microseconds (for two channel boards) or 12.8 microseconds (for four channel boards). The input impedance of the analog conversion circuit is 20,000 ohms. There is a 4 KHz noise filter on each input.



Figure 4-14: DB9 Connector

[Table 4-5](#) details the pin out for the analog input connector.

Table 4-5: Connector Pin Outs

Pin	Description
1	24VDC
2	24VDC (+/- 10 VDC input signal, channel 3 on selected controllers)
3	+/- 10VDC input signal, channel 2
4	+/- 10VDC input signal, channel 1
5	GND (+/- 10VDC input signal, channel 4 on selected controllers)
6	24VDC
7	GND
8	GND
9	GND
Interface Panel Connector Part No	DB9 Female Connector
User Plug Part No	DB9 Male Plug

Optional Auxiliary Encoder Interfaces

There are two optional encoder connectors located on the system's Interface Panel. These are auxiliary encoder interfaces that are not utilized to control the DENSO robot. These interfaces can be used to read the position of conveyor belts or other devices.

Each connector contains a set of three differential inputs for interfacing to an incremental, analog or absolute encoder. In addition, each connector has three single-ended inputs that can be interfaced to an additional incremental encoder or hall effect sensors or limit and home switches. The encoder connectors are numbered on the Interface Panel although the correspondence between connector number and logical encoder can be reassigned in software.



Figure 4-15: DB15 Connector

The following is a partial list of absolute encoders that are supported by the Guidance System.

1. 16-bit, 17-bit and 20-bit Yaskawa Sigma II/III encoders
2. Panasonic A4 Serial Incremental/Absolute encoders
3. Absolute encoders provided by Bosch with their line of industrial linear modules
4. Tamagawa SA35-17/33Bit-LPS-5V Absolute encoders and 17-bit serial incremental encoders

Certain absolute encoders and all analog encoders require special versions of the Guidance Controller to operate (contact Brooks at support_preciseflex@brooksautomation.com for further information). For specific information on connecting absolute encoders to the encoder interfaces, see the "Third Party Equipment" section of the *Controller Hardware Manual*.

If the set of three single-ended signals is configured for a second encoder, the single-ended encoder can be used independently of the differential input encoder. Alternately, these three digital inputs can be configured for hall-effect sensors or two over-travel sensors plus a homing sensor. When configured for these functions, these inputs should be treated as 5VDC sourcing digital inputs connections.

The following table defines the connector pin outs. The second column should be used when the three digital inputs are configured for hall-effect sensors or over-travel switches and a homing sensor. The third column describes the pin outs when a second, single-ended encoder is utilized.

Table 4-6: Connector Pin Outs

Pin	Three Digital Inputs (5VDC)	2 nd Encoder (5VDC)
1	Encoder 1A+ (Digital or Analog)	
2	5VDC provided to power encoders. The sum of the current drawn from all encoder connectors is limited to 1 Amp.	
3	Encoder 1 B- (Digital or Analog)	
4	Encoder 1 Z+ (Digital)	
5	Gnd	
6	Gnd (Reserved for Abs Encoder Bat Gnd)	
7	Vcc (Reserved for Abs Encoder Bat Pwr)	
8	Gnd	
9	Encoder 1 A- (Digital or Analog)	
10	Encoder 1 B+ (Digital or Analog)	
11	Gnd	
12	Encoder 1 Z- (Digital)	
13	Digital Input #1 Hall #1 or Homing Switch	Encoder 2 A+
14	Digital Input #2 Hall #2 or Positive Over-Travel	Encoder 2 B+
15	Digital Input #3 Hall #3 or Negative Over-Travel	Encoder 2 Z+
Interface Panel Connector Part No	DB15 Female Connector	
User Plug Part No	DB15 Male Plug	

Remote Front Panel/MCP/E-Stop Interface

The remote front panel interface includes all of the signals necessary to implement a fully compliant EC Category 3 (CAT-3) Safety front panel that includes a Manual Control Pendant. In particular, this connector provides signals (including redundancy as necessary) for implementing an E-Stop circuit, an auto/manual switch, a high power "on" button with a high power "on" indicator lamp, and a RS-232 interface for a Manual Control Pendant (MCP). These signals are provided in a DB25 female connector (see [Figure 4-16](#)) mounted on the Interface Panel of the Guidance System.

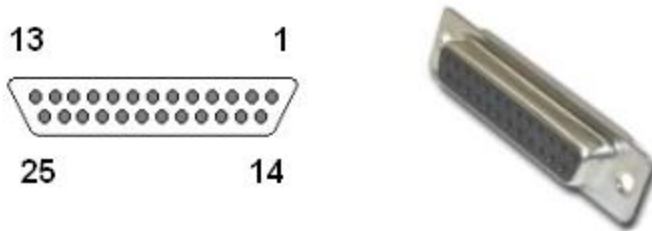

Figure 4-16: DB25 Female Connector

In the future, PreciseFlex may offer a Remote Front Panel option that plugs into this connector. Alternatively, customers can develop their own custom front panels (see the section on "Safety Circuits For Remote Front Panel" in the *Controller Hardware Manual* for a suggested design). Or, if the application does not require a fully compliant Category 3 (CAT-3) front panel, the controller can be operated without a front panel or with a PreciseFlex hardware MCP or a PreciseFlex E-Stop box. Both the PreciseFlex MCP and the E-Stop box can plug directly into the Remote Front Panel connector and provide a hardware emergency stop capability via the connector's redundant E-Stop signals.

When a front panel, hardware MCP or E-Stop box is not utilized, the following pins on the front panel connector must be jumpered in order for the controller to operate properly. (The controller is shipped with a jumper plug that satisfies these requirements.)

1-14, 2-15, 3-16, 4-17, 5-18, 6-19, 7-20

If a Manual Control Pendant is not connected to the secondary RS-232 port provided in this connector, this serial interface can be accessed via a GPL procedure as device `"/dev/com2"` for general communications purposes.

NOTE: Unlike the primary serial interface, this secondary serial interface does not support flow control.

Table 4-7: Pins, Connector, & Plug

Pin	Description
1	Auto/Manual 2 (If no front panel or Auto mode, connect to pin 14). Input signal that is high to indicate that the system is being operated in a fully automatic mode or low or open for manual operation. This is normally controlled by a key switch on the Remote Front Panel of the master controller. During Manual Mode, only Jog mode motions are permitted and the servos restrict the axes to special "Manual mode max torque %" and "Manual mode speed limits" to ensure that the system can be safely manually operated. When this signal changes from Auto to Manual, motor power is automatically turned off and must be re-enabled to move the robot. The Auto/Manual signal is daisy chained to all controllers in the servo network.
2	Auto/Manual 1 (If no front panel or Auto mode, connect to pin 15). Redundant Auto/Manual input signal.
3	ESTOP_L 2 (If no front panel or E-Stop not asserted, connect to pin 16). Input signal that is low or open to indicate that a hardware E-Stop condition has been asserted by any source. Set high if no E-Stop condition is asserted. The controller hardware will not permit motor power to be enabled when an E-Stop condition exists.
4	ESTOP_L 1 (If no front panel or E-Stop not asserted, connect to pin 17). Redundant ESTOP input signal.
5	External ESTOP_L (If no front panel or not an External ESTOP, connect to pin 18). Diagnostic input signal that is low when an E-Stop is generated from an external source. This allows the System Software to display different error messages to alert the operator as to the source of the E-Stop condition.
6	High Power Lamp Fail (If no front panel, jumper to pin 19). Input signal that is set high or open if the Remote Front Panel lamp, which indicates when motor power is enabled, has failed. When this signal is high, motor power cannot be enabled.
7	High Power Enable (If no front panel, jumper to pin 20). Input signal that must transition from low to high during the EC Category 3 (CAT-3) power enable sequence to request that motor power be enabled. This is normally connected to a momentary contact "Enable power" push button on the Remote Front Panel.
8	Not used
9	MCP RXD. RS-232 receiver serial line from the Manual Control Pendant or external device.
10	5VDC. WARNING - This voltage is provided as a convenience but is limited in the current that can be supplied. Drawing excessive current can damage the controller. Consult Brooks at support.preciseflex@brooksautomation.com if there is any question about the use of this voltage.
11	Not used
12	Not used
13	Not used
14	24VDC
15	24VDC

Pin	Description
16	Force ESTOP_L. Output signal that, when low, indicates that the Remote Front Panel should force ESTOP_L 1 and ESTOP_L 2 to be asserted (low). The System Software toggles this signal low at startup to verify that the ESTOP_L 1, ESTOP_L 2, and External ESTOP circuits are properly working. The System Software also uses this as a means for asserting a hardware E-Stop condition during normal operation. This signal is normally held high.
17	Force ESTOP_L. Redundant Force ESTOP_L output signal.
18	Force ESTOP_L. Redundant Force ESTOP_L output signal.
19	GND
20	GND
21	High Power Status. Output signal that is asserted (high) when high power to the motor is enabled. This is typically connected to a relay that turns on the High Power Lamp in the Remote Front Panel.
22	MCP TXD. RS-232 transmitter serial line to the Manual Control Pendant or external device.
23	5 VDC. WARNING - This voltage is provided as a convenience but is limited in the current that can be supplied. Drawing excessive current can damage the controller. Consult Brooks at support_preciseflex@brooksautomation.com if there is any question about the use of this voltage.
24	Not used
25	Not used
Interface Panel Connector Part No	DB25 Female Connector
User Plug Part No	DB25 Male Plug

RS-232 Serial Interface

The system includes a standard RS-232 serial line equipped with hardware or software flow control. This port can be used to communicate to the system serial console or can be connected to external equipment for general communication purposes. When used for general communications, this port is referenced as device "/dev/com1" within the Guidance Programming Language (GPL).

The connector for this interface is a female DB9 (see [Figure 4-17](#)) that has pin assignments compatible with standard PC "COM" ports. A straight through DB9 to DB9 cable can be used to connect the Guidance System to a PC.



Figure 4-17: DB9, Female

[Table 4-8](#) defines the pin assignments for this connector.

Table 4-8: Connector Pin Assignments

Pin Description	Pin Description
1	Not used
2	TXD - Transmit data
3	RXD - Receive data
4	Not used
5	GND
6	Not used
7	CTS - Clear to send for hardware flow control
8	RTS - Request to send for hardware flow control
9	Not used
Interface Panel Connector Part No	DB9 Female Connector
User Plug Part No	DB9 Male Plug

Appendices

Appendix A: Product Specifications

Guidance System D4/D6 Specifications

Table 5-1 contains the specifications for the Guidance System D4 and D6 models. "S" indicates a standard feature, "O" indicates an available optional feature, "-" denotes that the feature is not available for a specific model and a number indicates the number of facilities available.

Table 5-1: Guidance System D4 & D6 Specifications

General Specification	D4	D6	Range & Features
Computational Hardware			
CPU and Dynamic Memory	S	S	400Mhz high performance, low-power CPU with a minimum of 8 MB of dynamic RAM
Nonvolatile Memory	S	S	Flash disk with a minimum of 16 MB of storage for OS, firmware and user program and data storage
Software			
Programming Interface	S	S	Three programming methods available: <ul style="list-style-type: none"> • DIO MotionBlocks (PLC) • Embedded Guidance Programming Language (GPL) • PC/Unix controlled over Ethernet
Operator Interface	S	S	Web-based operator interface supports local or remote control via browser connected to embedded web server

General Specification	D4	D6	Range & Features
Motion Control	S	S	Extensive robotic and low-level motion control available Continuous path following, s-curve profiling Straight-line and circular motions Torque and velocity control Control of up to 32 axes via networked distributed control organized into up to twelve multi-axis robots Distributed control network can consist of up to 16 controllers
	O	O	Conveyor belt tracking Kinematic models for various robot geometries Advanced Controls License - Enables enhanced motion control modes including: high speed position latching, real-time trajectory modification, analog output controlled by robot speed, and support for EtherNet/IP
Machine Vision	O	O	Provides controller with a complete set of image-processing, measurement, inspection and finder tools. A powerful patented Object Locator finds parts in any orientation and at different scales within milliseconds.
Motion Control			
Motor Drives	S	-	DENSO 4-axis SCARA or Cartesian mechanism connects to system using standard DENSO robot cable Four integrated motor drives
	-	S	DENSO 6-axis Articulated mechanism connects to system using standard DENSO robot cable Six integrated motor drives. 5 th and 6 th motor drives provided by Guidance 0200C Slave Amplifier
	S	S	Current per motor: 10A peak/5.5A RMS/3.5A stall (all drives)
	O	O	Current per motor: 20A peak/10A RMS/6.5A stall (first 4 drives) Needed for all DENSO robots except for the small VP-G 6-axis mechanism
	S	S	Motor bus voltage: 320VDC Total power for all drives: 600 Watts RMS
Position Sensors Interface	S	S	Built-in interface to special DENSO absolute encoders
Auxiliary Position Sensors Interface	O	O	Two Auxiliary Encoder Interfaces that each contain: One differential incremental encoder input One single-ended incremental encoder interface Optional support for selected absolute encoders
	O	-	Support for analog encoders with interpolation
3 rd Party Amplifiers	-	-	DAC channels for controlling external amplifiers not available
Communications Interfaces			

General Specification	D4	D6	Range & Features
General Communications	S	S	RS-232 port with hardware flow control Remote front panel interface with second RS-232 port (no hardware flow control), compliant with IEC Category 3 (CAT-3) safety standards
Ethernet Ports	2	2	10/100 Mbps Ethernet ports
Digital Input Channels	S	S	12 general purpose optically isolated inputs, configurable in groups of four as sinking or sourcing, signals transition to a high or low in 4 usec. 5VDC to 24VDC for logic high if sinking 24VDC supplied for logic high if sourcing
	O	O	Additional remote I/O available via PreciseFlex RIO modules, 3 rd party MODBUS/TCP devices or EtherNet/IP
Digital Output Channels	S	S	Eight general purpose optically isolated outputs, individually configurable as sinking or sourcing, signals turn on in 3 usec and turn off within 400 usec. 24VDC maximum pull up if sinking 24VDC supplied if sourcing 100 mA maximum per channel for channels 2-7, 500 mA maximum for channel 1 (jumper configurable)
	O	O	Additional remote I/O available via PreciseFlex RIO modules, 3 rd party MODBUS/TCP devices, or 3 rd party EtherNet/IP devices
Valve Control Output	S	S	Last two standard digital output channels also used to control valve control signals: 24VDC output for 0.5 msec 3.9VDC output for duration of "on" time
Auxiliary Digital IO	S	S	Eight additional sinking isolated inputs, 4 msec scan time Eight additional sourcing isolated outputs, 4 msec scan time
	O	O	12VDC for powering Ethernet camera 9VDC for powering ring light, controllable via software
Analog I/O Channels	O	-	2 or 4 analog +/- 10 VDC 12-bit inputs
Dimensions			
Size and Weight	S	-	246.7 mm (W) x 320.1 mm (H) x 190 mm (D), 4.08 kg.
	-	S	294.7 mm (W) x 320.1 mm (H) x 215 mm (D).
	S	S	The depth includes approximately 40 mm for the protrusion of the DENSO motor plug. If rubber feet are attached, height will increase by approximately 13 mm.
Input AC			

General Specification	D4	D6	Range & Features
Input Voltage	S	S	90 to 264 VAC single-phase. NOTE: However, some mechanism may require 220 VAC single-phase to achieve maximum speed and acceleration.
Frequency	S	S	50 - 60Hz
Power	S	S	725 W maximum

Guidance System D4/D6 Environmental Specifications

The Guidance System D4/D6 must be installed in a clean, non-condensing environment with the following specifications:

Table 5-2: Guidance System D4/D6 Environmental Specifications

General Specification	Range & Features
Ambient temperature	5° C to 40° C
Ingress protection	IP51. Protected against light dust and water drips.
Storage and shipment temperature	-25° C to +55 °C
Humidity range	5 to 90%, non-condensing
Altitude	Up to 3000 m

Appendix B: FAQ

This section contains a compilation of frequently asked questions related to the Guidance System products.

1. [How do you connect a robot power enable button?](#)
2. [Why should grippers be wired to release when digital signals are ON?](#)
3. [What can you do if your GPL program is running too slowly?](#)

How do you connect a robot power enable button?

To connect a momentary contact button to enable robot power, wire the button to either a general digital input signal or use the dedicated input signal provided in the Remote Front Panel Connector.

If a user connects the button to a general DIN, the number of the DIN signal should be set as the "Power enable DIN" (DataID 242) parameter database value. If a user connects the button to the Remote Front Panel Connector "High Power On" input, the value of the dedicated input signal (DIN 18007) should be set as the value of DataID 242.

In either case, power will be enabled when the signal toggles from the OFF to the ON state.

Why should grippers be wired to release when digital signals are On?

Grippers or other tooling should always be wired to digital output signals such that an active (ON) state will release a part. This is an important practice since if the controller loses power and is restarted, all output signals are turned OFF by default. If a gripper is wired to release a part with an OFF signal, any parts left in a gripper from a previous operation would be dropped when the controller is restarted.

What can you do if your GPL program is running too slowly?

Most people find that the Guidance Controllers provide a great deal more computational power than their application requires. However, if a users finds that their GPL programs are executing more slowly than desired, the following are some of the more common causes and the corrective actions.

1. Some user threads may be consuming time in busy loops.
If the application executes multiple threads, it is very important that each thread relinquishes control of the processor whenever it has completed execution or is waiting for the completion of an operation. The following are some suggestions:
 - Try to use SendEvent and WaitEvent methods to coordinate the execution of multiple threads instead of Sleep loops with explicit tests. When a thread is stopped due to a

WaitEvent, the thread consumes no execution time until the event is signaled.

- If a user must poll, execute a Thread.Sleep between each test and ensure that they make the sleep duration as long as possible.

2. Servo processing may be consuming too much of the available CPU time.

Servo processes consume a rather fixed amount of execution time even if an axis is not moving. If a user is running many local servos (especially in 6-axis controllers) or if they have many networked servos, a significant amount of available CPU can be consumed on the master controller. To reduce this load, try any of the following:

- Increase the "Trajectory Generator update period in sec" (DataID 600) to 0.004 or longer. This is especially important on Servo Network systems.
- Increase the "Servo update period in sec" (DataID 603) from the default of 0.000125 to 0.000250.
- Increase the "Position loop update rate, second" (DataID 10021) from 0.0005 to 0.001.

Appendix C: Spare Parts Lists

Table 5-3: Spare Parts

Description	Part Number
Enhanced G24x0 Controller	G2XA-EA-C2410 or G2XA-EA-C2420 or G2XA-EA-B2410 or G2XA-EA-B2420
Guidance 0210C Slave Amplifier (D6 only)	G2X0-EA-C0210
125 Wt 24VDC Power Supply	PS10-EP-00125
PrecisePower 300/600 W Intelligent Motor Power Supply	PS1D-EA-00300
Fuse, PrecisePower 300/600 W Motor Power Supply	Wickman PN 1941630000
24VDC Fan	0000-EC-X0009
Fan Filter Assembly	G1S0-MC-X0002
Auxiliary IO Board	PF13-EA-00001
Valve / Brake Control Board	G2S0-EA-00003

Appendix D: System Schematics

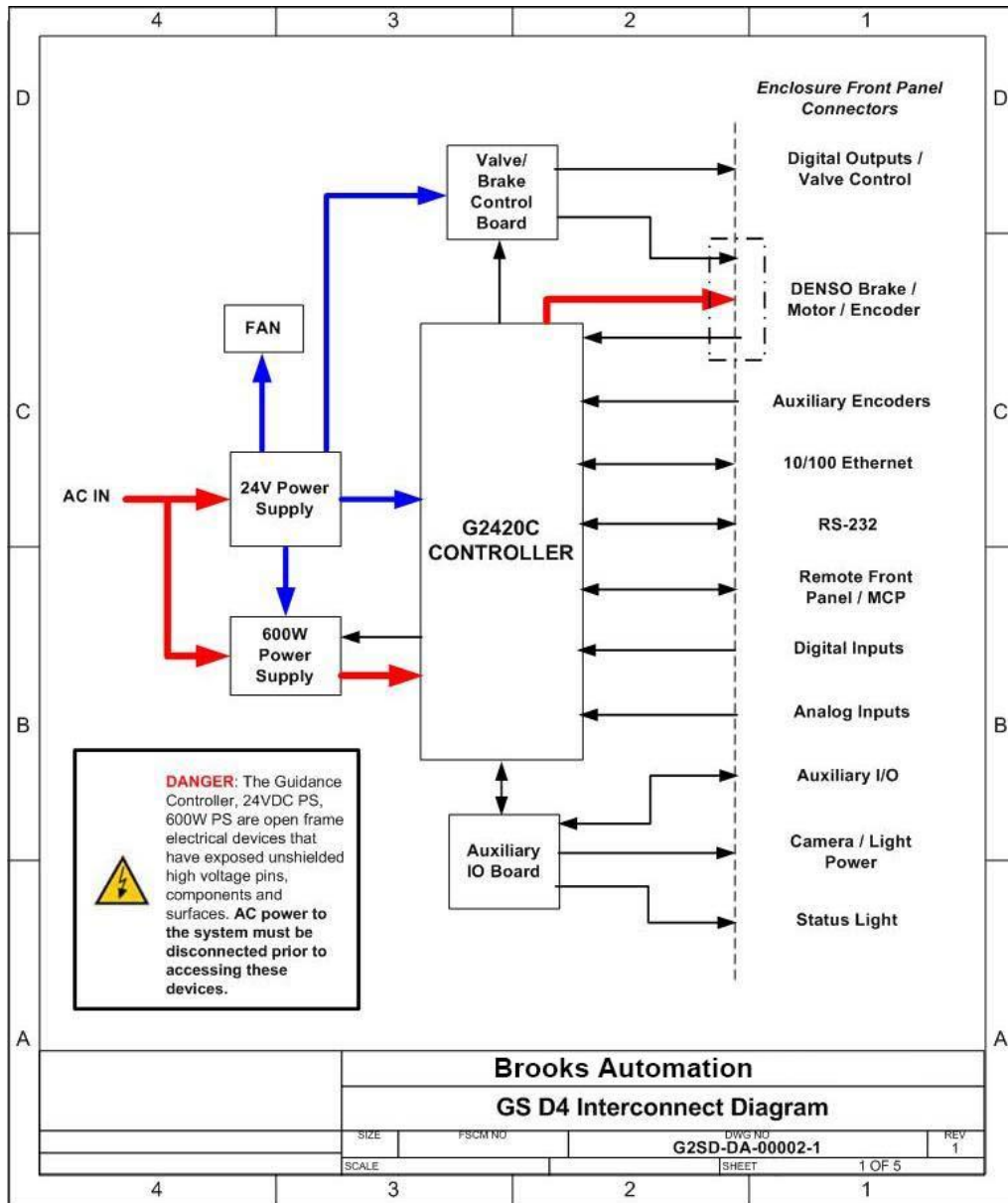

Figure 5-1: GS D4 Interconnect Diagram

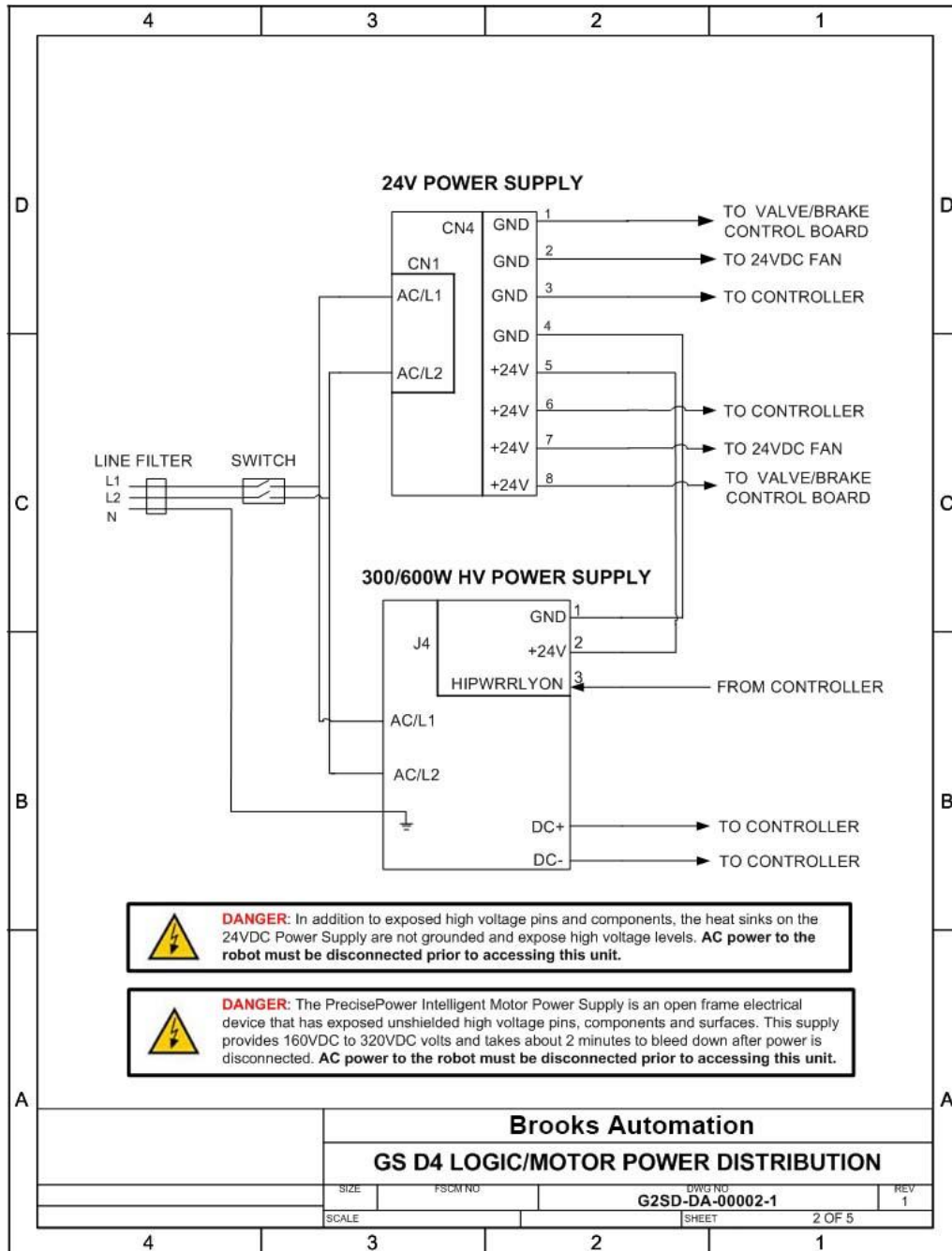

Figure 5-2: GS D4 Logic/Motor Power Distribution

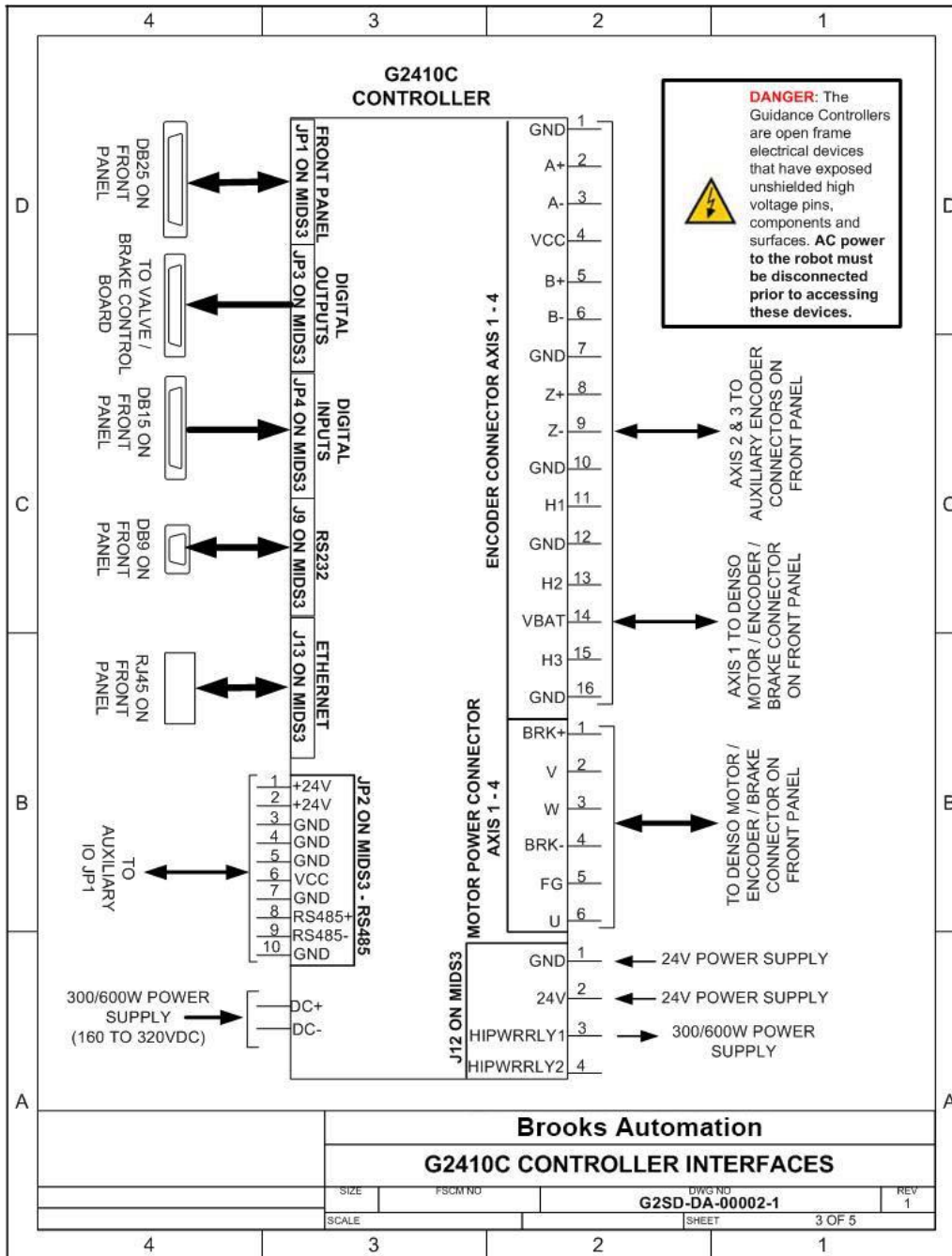

Figure 5-3: G2410C Controller Interfaces

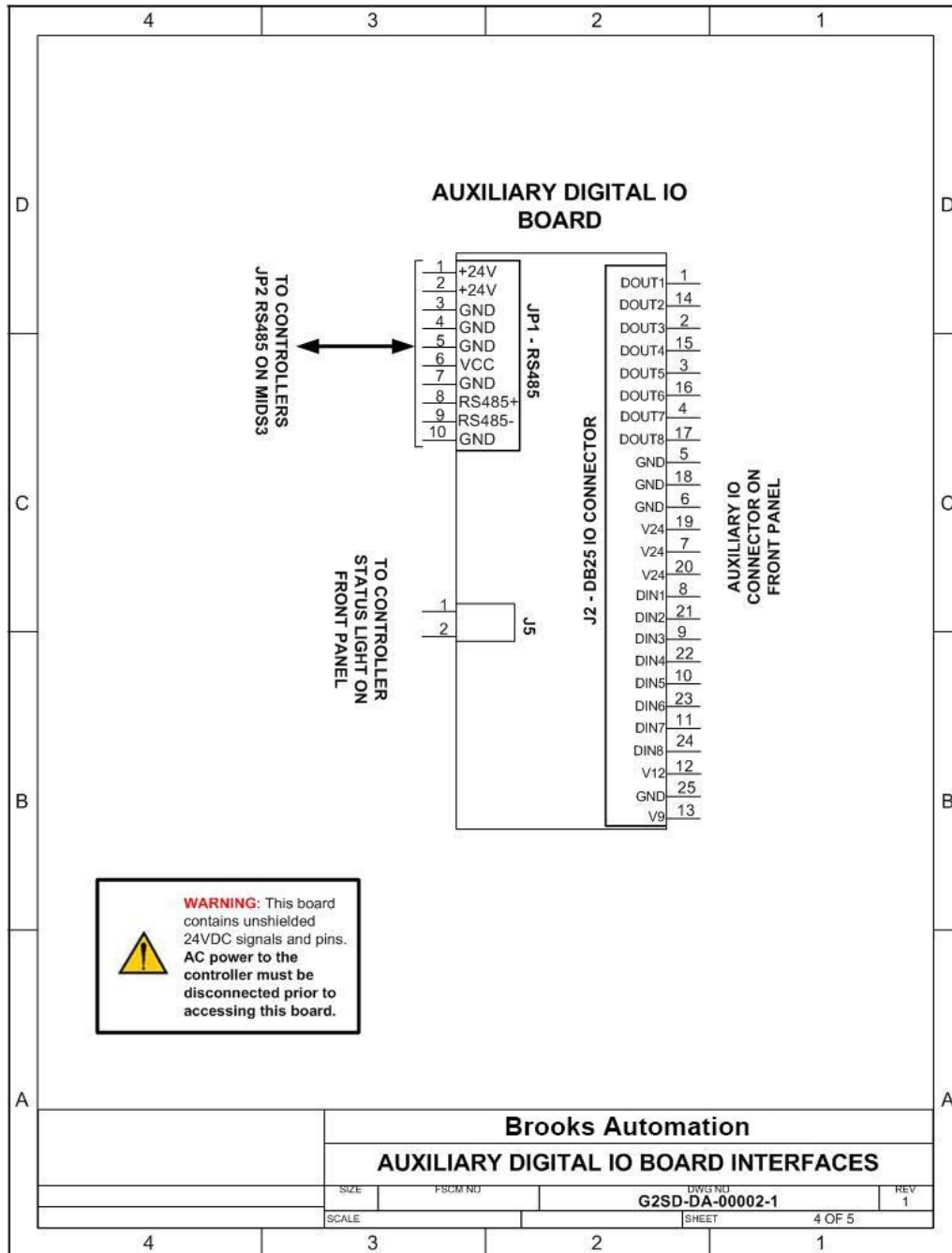

Figure 5-4: Auxiliary Digital I/O Board Interfaces

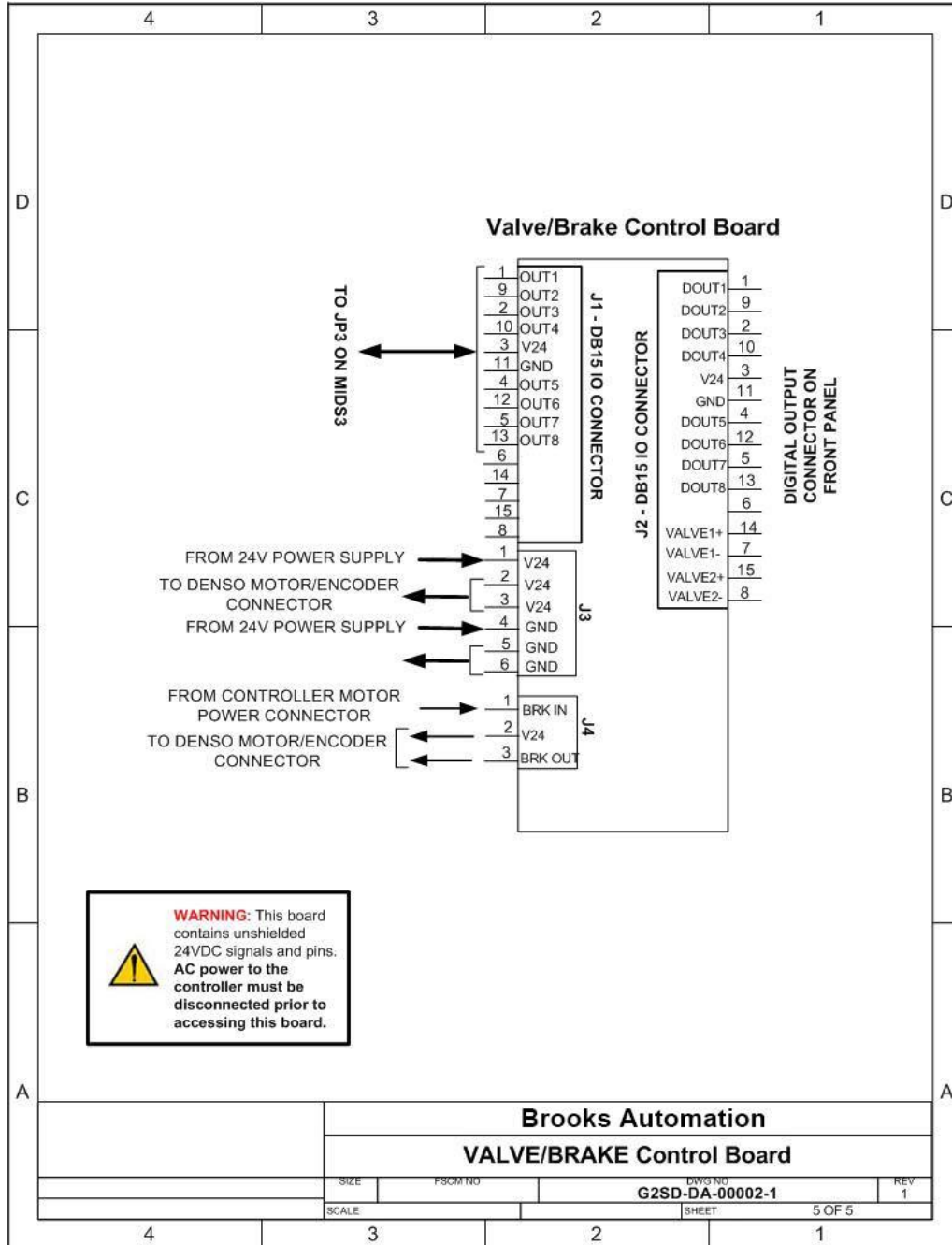

Figure 5-5: Valve/Brake Control Board